

**PHỤ KIỆN U-PVC PHỔ THÔNG**
**Nối góc 90°, Nối góc 90° loại phổ thông - Elbow 90°, Normal Elbow 90°**

Mã số Code	Kích cỡ Size	PN (Bar)	L	Z	Kiểu dạng Shape	Đơn giá Unit Price (VND/cái)
FPV/GV21/PT/10	21	10	16.5	12	T	1.500
FPV/GV21/PT/16	21	16	30	13	T	3.200
FPV/GV27/PT/10	27	10	20	16	T	2.200
FPV/GV27/PT/16	27	16	35	16	T	3.900
FPV/GV34/PT/12.5	34	12.5	23	18.8	T	4.000
FPV/GV34/PT/16	34	16	23	18.8	T	6.900
FPV/GV42/PT/10	42	10	27	22.7	T	5.600
FPV/GV42/PT/16	42	16	27	22.7	T	10.800
FPV/GV48/PT/10	48	10	30	26	T	9.000
FPV/GV48/PT/16	48	16	30	26	T	14.800
FPV/GV60/PT/6	60	6	36	32	T	12.600
FPV/GV60/PT/8	60	8	36	32.9	T	13.200
FPV/GV60/16	60	16	32	39	T	23.500
FPV/GV75/PT/6	75	6	43.5	40	T	22.300
FPV/GV75/PT/8	75	8	44	40.2	T	23.500
FPV/GV75/10	75	10	40	45	T	42.300
FPV/GV90/PT/6	90	6	51	48	T	28.900 *
FPV/GV90/PT/8	90	8	51	49.2	T	31.500
FPV/GV110/PT/6	110	6	61	58	T	46.200 *
FPV/GV110/PT/8	110	8	61	58	T	49.300
FPV/GV110/10	110	10	48	72	T	76.800
FPV/GV125/PT/6	125	6	68.5	68	T	86.500 *
FPV/GV125/PT/8	125	8	69	65.5	T	91.100
FPV/GV140/PT/6	140	6	76	74	T	125.300 *
FPV/GV160/PT/6	160	6	86	84	T	151.200 *
FPV/GV180/PT/10	180	10	105	106	T	325.500
FPV/GV200/PT/6	200	6	106	105	T	309.500 *
FPV/GV225/PT/10	225	10	119	124	T	649.600
FPV/GV280/PT/10	280	10	147	149	T	3.060.000
FPV/GV315/PT/6	315	6	-	-	T	1.617.000
FPV/GV315/PT/10	315	10	164	161.5	T	3.462.000
FPV/GV355/PT/10	355	10	184	185.5	T	9.063.000
FPV/GV400/PT/10	400	10	206	210	T	9.809.000

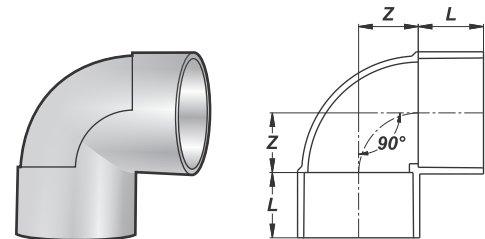
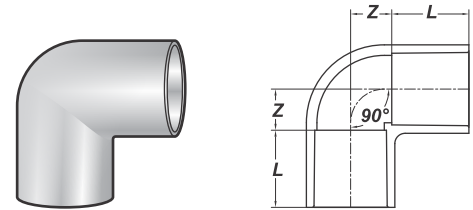

Kiểu T

**Nối góc 45° loại phổ thông - Normal Elbow 45°**

Mã số Code	Kích cỡ Size	PN (Bar)	L	Z	Kiểu dáng Shape	Đơn giá Unit Price (VND/cái)
FPV/CH21/PT/10	21	10	16.5	8	T	1.500
FPV/CH21/PT/16	21	16	30	7	T	1.800
FPV/CH27/PT/10	27	10	19.5	10	T	2.000
FPV/CH27/PT/16	27	16	35	8	T	2.100
FPV/CH34/PT/10	34	10	22	14	T	2.800
FPV/CH34/PT/16	34	16	22	14	T	5.900
FPV/CH42/PT/10	42	10	27	10.9	T	4.300
FPV/CH48/PT/10	48	10	30	12.2	T	6.800
FPV/CH60/PT/6	60	6	36	15	T	10.800
FPV/CH60/PT/8	60	8	36	15.7	T	11.200
FPV/CH60/PT/16	60	16	40.5	15.3	T	20.800
FPV/CH75/PT/6	75	6	43.5	18	T	18.500
FPV/CH75/PT/8	75	8	44	20.2	T	19.500
FPV/CH90/PT/6	90	6	51	21	T	23.800 *
FPV/CH90/PT/8	90	8	51	23.3	T	25.300
FPV/CH110/PT/6	110	6	61	25	T	36.300
FPV/CH110/PT/8	110	8	61	24.6	T	38.800
FPV/CH125/PT/6	125	6	68.5	29	T	64.300 *
FPV/CH125/PT/8	125	8	69	28.5	T	68.500
FPV/CH140/PT/6	140	6	76	32	T	74.600
FPV/CH160/PT/6	160	6	81	36	T	113.000
FPV/CH180/PT/10	180	10	105	55	T	223.800
FPV/CH280/PT/10	280	10	147	149	T	2.102.000
FPV/CH315/PT/10	315	10	164	161.5	T	2.510.000
FPV/CH355/PT/10	355	10	-	-	T	6.705.000
FPV/CH400/PT/10	400	10	206	210	T	7.692.000

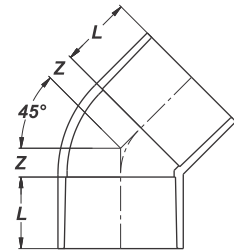

Kiểu T

**Góc uốn 18° - Bends 18°**

Mã số Code	Kích cỡ Size	PN (Bar)	L	H	Kiểu dáng Shape	Đơn giá Unit Price (VND/cái)
FPV/GU60/10	60	10	-	500	T	109.300
FPV/GU75/10	75	10	-	500	T	191.500
FPV/GU90/10	90	10	-	700	T	273.500
FPV/GU110/10	110	10	-	700	T	382.900
FPV/GU125/10	125	10	-	700 ÷ 1000	T	464.900
FPV/GU140/10	140	10	-	700 ÷ 1000	T	696.200
FPV/GU160/10	160	10	-	700 ÷ 1000	T	820.500
FPV/GU180/10	180	10	-	700 ÷ 1000	T	
FPV/GU200/10	200	10	-	700 ÷ 1000	T	1.231.000
FPV/GU225/10	225	10	-	700 ÷ 1000	T	
FPV/GU250/10	250	10	-	700 ÷ 1000	T	1.915.000

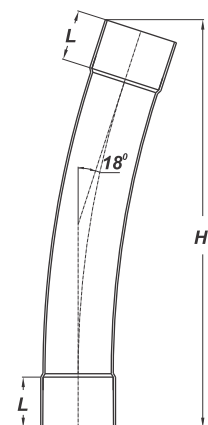

Kiểu T

 Mã trên là mã sản phẩm màu ghi. Muốn đặt sản phẩm màu trắng thêm **WH** vào cuối. VD: Mã **FPV/T75/8** sẽ thành **FPV/T75/8/WH**

**Nối thẳng - Coupling**

Mã số Code	Kích cỡ Size	PN (Bar)	L	Z	H	Kiểu dáng Shape	Đơn giá Unit Price (VND/cái)
FPV/N21/10	21	10	24	2.0	50	T	1.300
FPV/N21/16	21	16	30	1.8	64	T	2.100
FPV/N27/10	27	10	25	2.3	54.3	T	1.800
FPV/N27/16	27	16	35	1.0	74	T	2.900
FPV/N34/10	34	10	29	2.0	60	T	2.000
FPV/N34/16	34	16	28	2.0	58	T	5.500
FPV/N42/10	42	10	31	2.0	64	T	3.500
FPV/N42/16	42	16	31	2.0	64	T	9.600
FPV/N48/10	48	10	34	2.0	70	T	4.500
FPV/N48/16	48	16	34	2.0	70	T	10.800
FPV/N60/10	60	10	41	2.0	84	T	8.400
FPV/N60/16	60	16	41	2.0	84	T	16.800
FPV/N75/8	75	8	50.5	4.0	105	T	10.400
FPV/N75/10	75	10	51	3.0	105	T	10.600
FPV/N90/6	90	6	51	4.0	106	T	13.300
FPV/N90/8	90	8	58	3.0	119	T	14.100
FPV/N90/10	90	10	58	3.0	119	T	33.800
FPV/N110/6	110	6	61	5.0	127	T	16.800
FPV/N110/8	110	8	61	3.5	125.5	T	17.900
FPV/N110/10	110	10	61	3.5	125.5	T	50.000
FPV/N125/8	125	8	68	8.5	144.5	T	40.300
FPV/N125/10	125	10	66	4.0	136	T	71.800
FPV/N140/6	140	6	76	8.0	160	T	54.500 *
FPV/N140/8	140	8	69	5.5	144	T	58.000
FPV/N140/10	140	10	69	5.5	144	T	82.800
FPV/N160/6	160	6	86	8.0	180	T	77.500 *
FPV/N160/8	160	8	77	3.5	141.5	T	82.800
FPV/N160/10	160	10	77	3.5	141.5	T	130.900
FPV/N200/6	200	6	106	10.0	222	T	171.500 *
FPV/N200/8	200	8	93	4.5	190.5	T	182.400
FPV/N200/10	200	10	82	3.5	167.5	T	219.100
FPV/N225/10	225	10	119	4.0	242	T	221.200
FPV/N250/10	250	10	95	3.0	193	T	661.400
FPV/N280/10	280	10	147	5.0	304	T	1.373.000
FPV/N315/10	315	10	164	8.0	344	T	2.152.000
FPV/N355/10	355	10	184	5.0	378	T	3.617.000
FPV/N400/10	400	10	206	3.5	419	T	3.959.000

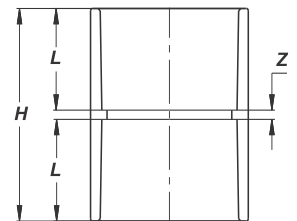

Kiểu T

**Nối thẳng nông - Coupling**

Mã số Code	Kích cỡ Size	PN (Bar)	L	Z	H	Kiểu dáng Shape	Đơn giá Unit Price (VND/cái)
FPV/NN75/10	75	10	76	8	160	T	30.600
FPV/NN90/8	90	8	85	8	178	T	24.900
FPV/NN90/10	90	10	85	8	178	T	36.100
FPV/NN90/16	90	16	85	8	178	T	186.500
FPV/NN110/8	110	8	97	13	207	T	43.600
FPV/NN110/10	110	10	97	13	207	T	72.000
FPV/NN110/16	110	16	97	13	207	T	310.800
FPV/NN125/8	125	8	100	15	215	T	56.000
FPV/NN125/10	125	10	100	15	215	T	121.900
FPV/NN125/12.5	125	12.5	100	15	215	T	146.200
FPV/NN125/16	125	16	100	15	215	T	292.200
FPV/NN140/8	140	8	112	21	245	T	62.200
FPV/NN140/10	140	10	112	21	245	T	134.500
FPV/NN140/12.5	140	12.5	112	21	245	T	161.800
FPV/NN140/16	140	16	112	21	245	T	435.100
FPV/NN160/8	160	8	121	25	267	T	84.600
FPV/NN160/10	160	10	121	25	267	T	177.200
FPV/NN160/12.5	160	12.5	121	25	267	T	212.600
FPV/NN160/16	160	16	121	25	267	T	484.800
FPV/NN180/10	180	10	-	-	-	T	232.000
FPV/NN200/8	200	8	145	25	315	T	106.600
FPV/NN200/10	200	10	145	25	315	T	261.100
FPV/NN200/12.5	200	12.5	145	25	315	T	447.600
FPV/NN225/8	225	8	160	35	365	T	168.900
FPV/NN225/10	225	10	160	35	365	T	522.100
FPV/NN250/8	250	8	175	35	385	T	184.000
FPV/NN280/5	280	5	195	35	425	T	323.200
FPV/NN315/5	315	5	215	40	470	T	522.100

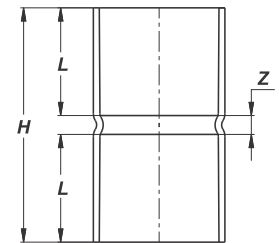
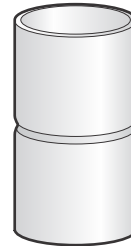

Kiểu T

**Nối thẳng trượt không có gờ - Metric Socket Adaptor**

Mã số Code	Kích cỡ Size	PN (Bar)	H	Kiểu dáng Shape	Đơn giá Unit Price (VND/cái)
FPV/NTKG42/10	42	10	450	T	37.100
FPV/NTKG48/10	48	10	450	T	48.500
FPV/NTKG60/8	60	8	450	T	54.800
FPV/NTKG60/10	60	10	450	T	68.400
FPV/NTKG75/8	75	8	450	T	67.100
FPV/NTKG75/10	75	10	450	T	91.400
FPV/NTKG90/8	90	8	450	T	139.400
FPV/NTKG90/10	90	10	450	T	166.800
FPV/NTKG90/12.5	90	12.5	450	T	209.200
FPV/NTKG110/8	110	8	450	T	164.100
FPV/NTKG110/10	110	10	450	T	207.100
FPV/NTKG110/12.5	110	12.5	450	T	257.900
FPV/NTKG125/8	125	8	450	T	201.900
FPV/NTKG125/10	125	10	450	T	261.900
FPV/NTKG125/12.5	125	12.5	450	T	321.200
FPV/NTKG140/8	140	8	450	T	237.500
FPV/NTKG140/10	140	10	450	T	373.300
FPV/NTKG140/12.5	140	12.5	450	T	462.500
FPV/NTKG160/8	160	8	450	T	274.800
FPV/NTKG160/10	160	10	450	T	459.500
FPV/NTKG160/12.5	160	12.5	450	T	566.900
FPV/NTKG180/8	180	8	450	T	338.100
FPV/NTKG180/10	180	10	450	T	554.700
FPV/NTKG180/12.5	180	12.5	450	T	683.800
FPV/NTKG200/8	200	8	450	T	475.900
FPV/NTKG200/10	200	10	450	T	754.900
FPV/NTKG200/12.5	200	12.5	450	T	935.900
FPV/NTKG225/8	225	8	450	T	717.900
FPV/NTKG225/10	225	10	450	T	901.600
FPV/NTKG225/12.5	225	12.5	450	T	1.119.000

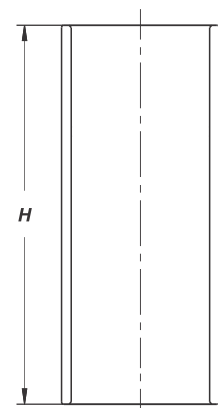

Kiểu T

**Nối thẳng trượt có gờ - Metric Socket Adaptor With Blocking Edge**

Mã số Code	Kích cỡ Size	PN (Bar)	L1	L2	H	Kiểu dáng Shape	Đơn giá Unit Price (VND/cái)
FPV/NTG42/10	42	10	300	100	450	T	39.800
FPV/NTG48/10	48	10	300	100	450	T	51.900
FPV/NTG60/8	60	8	300	100	450	T	58.000
FPV/NTG60/10	60	10	300	100	450	T	72.600
FPV/NTG60/10L	60	10	400	400	850	T	136.800
FPV/NTG60/12.5	60	12.5	300	100	450	T	88.000
FPV/NTG60/12.5L	60	12.5	400	400	850	T	166.500
FPV/NTG75/8	75	8	300	100	450	T	71.500
FPV/NTG75/10	75	10	300	100	450	T	89.200
FPV/NTG75/10L	75	10	400	400	850	T	168.500
FPV/NTG75/12.5	75	12.5	300	100	450	T	108.500
FPV/NTG75/12.5L	75	12.5	400	400	850	T	204.800
FPV/NTG90/8	90	8	300	100	450	T	146.500
FPV/NTG90/10	90	10	300	100	450	T	174.800
FPV/NTG90/10L	90	10	400	400	850	T	330.200
FPV/NTG90/12.5	90	12.5	300	100	450	T	219.500
FPV/NTG90/12.5L	90	12.5	400	400	850	T	414.700
FPV/NTG110/8	110	8	300	100	450	T	172.300
FPV/NTG110/10	110	10	300	100	450	T	220.100
FPV/NTG110/10L	110	10	400	400	850	T	415.900
FPV/NTG110/12.5	110	12.5	300	100	450	T	270.800
FPV/NTG110/12.5L	110	12.5	400	400	850	T	511.600
FPV/NTG125/8	125	8	300	100	450	T	212.000
FPV/NTG125/10	125	10	300	100	450	T	270.800
FPV/NTG125/10L	125	10	400	400	850	T	511.600
FPV/NTG125/12.5	125	12.5	300	100	450	T	333.000
FPV/NTG125/12.5L	125	12.5	400	400	850	T	629.000
FPV/NTG140/8	140	8	300	100	450	T	250.300
FPV/NTG140/10	140	10	300	100	450	T	392.600
FPV/NTG140/10L	140	10	400	400	850	T	741.300
FPV/NTG140/12.5	140	12.5	300	100	450	T	486.100
FPV/NTG140/12.5L	140	12.5	400	400	850	T	918.500
FPV/NTG160/8	160	8	300	100	450	T	290.000
FPV/NTG160/10	160	10	300	100	450	T	482.800
FPV/NTG160/10L	160	10	400	400	850	T	911.900
FPV/NTG160/12.5	160	12.5	300	100	450	T	595.500
FPV/NTG160/12.5L	160	12.5	400	400	850	T	1.125.000
FPV/NTG180/8	180	8	300	100	450	T	356.500
FPV/NTG180/10	180	10	300	100	450	T	593.800
FPV/NTG180/10L	180	10	400	400	850	T	1.122.000
FPV/NTG180/12.5	180	12.5	300	100	450	T	732.600
FPV/NTG180/12.5L	180	12.5	400	400	850	T	1.384.000
FPV/NTG200/8	200	8	300	100	450	T	500.500
FPV/NTG200/10	200	10	300	100	450	T	791.800
FPV/NTG200/10L	200	10	400	400	850	T	1.496.000
FPV/NTG200/12.5	200	12.5	300	100	450	T	981.500
FPV/NTG200/12.5L	200	12.5	400	400	850	T	1.861.000
FPV/NTG225/8	225	8	300	100	450	T	754.900
FPV/NTG225/10	225	10	300	100	450	T	947.900
FPV/NTG225/10L	225	10	400	400	850	T	1.791.000
FPV/NTG225/12.5	225	12.5	300	100	450	T	1.176.000
FPV/NTG225/12.5L	225	12.5	400	400	850	T	2.222.000

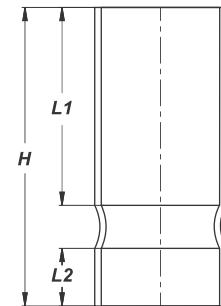

Kiểu T

**Nối thu đồng tâm nông - Reducing Pipe Coupling**

Mã số Code	Kích cỡ Size	PN (Bar)	h1	h2	H	Kiểu dạng Shape	Đơn giá Unit Price (VND/cái)
FPV/NTLN225160/5	225 x 160	5	115	140	310	T	<b>277.500</b>
FPV/NTLN225200/6	225 x 200	6	125	140	305	T	<b>348.100</b>
FPV/NTLN250200/6	250 x 200	6	150	155	325	T	<b>359.900</b>
FPV/NTLN250225/5	250 x 225	5	140	155	345	T	<b>392.600</b>
FPV/NTLN280250/10	280 x 250	10	131	146		T	<b>764.500</b>
FPV/NTLN315160/10	315 x 160	10	86	164		T	<b>846.800</b>
FPV/NTLN315200/10	315 x 200	10	106	164		T	<b>846.800</b>
FPV/NTLN315250/10	315 x 250	10	131	164		T	<b>846.800</b>
FPV/NTLN315280/10	315 x 280	10	146	164		T	<b>846.800</b>
FPV/NTLN355200/10	355 x 200	10	106	184		T	<b>1.242.000</b>
FPV/NTLN355225/10	355 x 225	10	119	184		T	<b>1.242.000</b>
FPV/NTLN355315/10	355 x 315	10	164	184		T	<b>1.424.000</b>
FPV/NTLN400200/10	400 x 200	10	106	206		T	<b>1.552.000</b>
FPV/NTLN400250/10	400 x 250	10	131	206		T	<b>1.552.000</b>
FPV/NTLN400315/10	400 x 315	10	164	206		T	<b>1.552.000</b>
FPV/NTLN400355/10	400 x 355	10	184	206		T	<b>1.552.000</b>

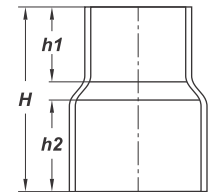
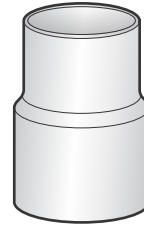

Kiểu T

**Đầu nối thông sàn - Floor Coupling**

Mã số Code	Kích cỡ Size	L	Z	H	Kiểu dạng Shape	Đơn giá Unit Price (VND/cái)
FPV/NTS42	42	40	35	115	T	<b>10.300</b>
FPV/NTS48	48	40	35	115	T	<b>12.100</b>
FPV/NTS60	60	40	35	115	T	<b>13.800</b>
FPV/NTS75	75	40	35	115	T	<b>19.600</b>
FPV/NTS90	90	40	35	115	T	<b>23.300</b>
FPV/NTS110	110	40	35	115	T	<b>28.600</b>
FPV/NTS125	125	40	35	115	T	<b>29.800</b>

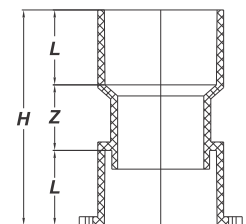

Kiểu T

 Mã trên là mã sản phẩm màu ghi. Muốn đặt sản phẩm màu trắng thêm **WH** vào cuối. VD: Mã **FPV/T75/8** sẽ thành **FPV/T75/8/WH**

**Nối thu đồng tâm dạng nối ngoài - Reducing Pipe Coupling**

Mã số Code	Kích cỡ Size	PN (Bar)	L	L1	H	Kiểu dáng Shape	Đơn giá Unit Price (VND/cái)
FPV/NTL2721/10	27 x 21	10	19.5	16.5	40.3	T	1.300
FPV/NTL3421/10	34 x 21	10	23	16.5	48	T	2.000
FPV/NTL3427/10	34 x 27	10	23	19.5	48	T	2.500
FPV/NTL4221/10	42 x 21	10	27	16.5	58.5	T	2.800
FPV/NTL4227/10	42 x 27	10	27	19.5	57	T	3.100
FPV/NTL4234/10	42 x 34	10	27	23	59.5	T	3.200
FPV/NTL4821/10	48 x 21	10	30	16.5	65	T	3.900
FPV/NTL4827/10	48 x 27	10	30	19.5	65	T	4.000
FPV/NTL4834/10	48 x 34	10	30	23	61	T	4.300
FPV/NTL4842/10	48 x 42	10	30	26.8	61.6	T	4.300
FPV/NTL6021/8	60 x 21	8	36	16.5	73	T	5.500
FPV/NTL6021/10	60 x 21	10	36	16.5	73	T	5.600
FPV/NTL6027/8	60 x 27	8	36	19.5	72.5	T	6.500
FPV/NTL6027/10	60 x 27	10	36	19.5	72.5	T	6.700
FPV/NTL6034/8	60 x 34	8	36	19.5	72.5	T	6.500
FPV/NTL6034/10	60 x 34	10	36	24	73	T	8.500
FPV/NTL6042/8	60 x 42	8	35	27	73	T	6.500
FPV/NTL6042/10	60 x 42	10	36	27	73	T	7.500
FPV/NTL6048/8	60 x 48	8	36	30	72.2	T	6.800
FPV/NTL6048/10	60 x 48	10	36	30	72.2	T	8.800
FPV/NTL7527/8	75 x 27	8	45.8	25	92	T	9.900
FPV/NTL7527/10	75 x 27	10	45.8	25	92	T	11.000
FPV/NTL7534/8	75 x 34	8	46	22.8	92.6	T	10.100
FPV/NTL7534/10	75 x 34	10	46	22.8	92.6	T	12.400
FPV/NTL7542/8	75 x 42	8	45.5	27.3	92	T	10.100
FPV/NTL7542/10	75 x 42	10	45.5	27.3	92	T	12.100
FPV/NTL7548/8	75 x 48	8	43.5	30	92.5	T	10.600
FPV/NTL7548/10	75 x 48	10	43.5	30	92.5	T	15.800
FPV/NTL7560/8	75 x 60	8	43.5	36	92.1	T	11.300
FPV/NTL7560/10	75 x 60	10	43.5	36	92.1	T	15.800
FPV/NTL9034/6	90 x 34	6	51	23	107	T	12.000
FPV/NTL9034/8	90 x 34	8	51	23	104.4	T	12.900
FPV/NTL9034/10	90 x 34	10	51	23	102.7	T	22.500
FPV/NTL9042/6	90 x 42	6	51	27	107	T	13.200
FPV/NTL9042/8	90 x 42	8	51	27	103	T	14.000
FPV/NTL9042/10	90 x 42	10	51	26	103	T	19.500
FPV/NTL9048/6	90 x 48	6	51	30	107	T	13.200 *
FPV/NTL9048/8	90 x 48	8	51	30	104.3	T	14.000
FPV/NTL9048/10	90 x 48	10	51	30	104	T	21.800
FPV/NTL9060/6	90 x 60	6	51	36	107	T	13.600 *
FPV/NTL9060/8	90 x 60	8	51	36	103	T	14.600
FPV/NTL9060/10	90 x 60	10	52.5	35.5	103.5	T	21.800
FPV/NTL9075/6	90 x 75	6	51	43.5	107	T	14.800 *
FPV/NTL9075/8	90 x 75	8	51	43.5	103.4	T	15.800
FPV/NTL9075/10	90 x 75	10	50.5	43.5	103	T	26.800
FPV/NTL11034/6	110 x 34	6	61	23	119	T	20.900 *
FPV/NTL11034/8	110 x 34	8	61	23	127	T	22.300
FPV/NTL11042/8	110 x 42	8	61	27	127	T	21.500
FPV/NTL11048/6	110 x 48	6	61	30	120	T	20.900 *
FPV/NTL11048/8	110 x 48	8	61	30	127	T	21.500
FPV/NTL11048/10	110 x 48	10	61	30	127	T	32.200
FPV/NTL11060/6	110 x 60	6	61	36	127	T	21.200 *
FPV/NTL11060/8	110 x 60	8	61	36	127	T	22.500
FPV/NTL11060/10	110 x 60	10	61	35.5	126	T	31.600
FPV/NTL11075/6	110 x 75	6	61	43.5	127	T	21.200 *
FPV/NTL11075/8	110 x 75	8	61	43.5	127	T	22.600
FPV/NTL11075/10	110 x 75	10				T	32.800
FPV/NTL11090/6	110 x 90	6	61	51	127	T	21.800 *
FPV/NTL11090/8	110 x 90	8	61	51	127	T	23.300

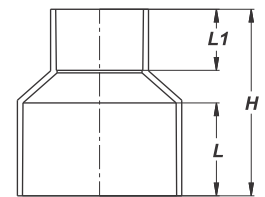

Kiểu T

**Nối thu đồng tâm dạng nối ngoài - Reducing Pipe Coupling**

Mã số Code	Kích cỡ Size	PN (Bar)	L	L1	H	Kiểu dạng Shape	Đơn giá Unit Price (VND/cái)
FPV/NTL11090/10	110 x 90	10	61	50.5	125	T	35.300
FPV/NTL12575/8	125 x 75	8	68.5	43.5	144	T	32.500
FPV/NTL12575/10	125 x 75	10	68.5	43.5	144	T	34.200
FPV/NTL12590/6	125 x 90	6	68.5	51	144	T	32.000
FPV/NTL12590/8	125 x 90	8	69	50.5	144	T	34.300
FPV/NTL12590/10	125 x 90	10	68.5	51	144	T	36.200
FPV/NTL125110/6	125 x 110	6	68.5	51	144	T	38.900
FPV/NTL125110/8	125 x 110	8	68.5	61	144	T	41.500
FPV/NTL125110/10	125 x 110	10	68.5	61	144	T	68.500
FPV/NTL14090/6	140 x 90	6	76	51	157	T	45.200
FPV/NTL14090/8	140 x 90	8	76	51	157	T	48.200
FPV/NTL14090/10	140 x 90	10	76	51	157	T	53.000
FPV/NTL140110/6	140 x 110	6	76	61	157	T	47.800 *
FPV/NTL140110/8	140 x 110	8	76	61	157	T	51.000
FPV/NTL140110/10	140 x 110	10	76	61	157	T	97.800
FPV/NTL140125/8	140 x 125	8	76	68.5	157	T	60.300
FPV/NTL140125/10	140 x 125	10	76	68.5	157	T	97.800
FPV/NTL16090/6	160 x 90	6	86	51	177	T	60.800 *
FPV/NTL16090/8	160 x 90	8	86	51	177	T	64.800
FPV/NTL16090/10	160 x 90	10	86	51	177	T	103.000
FPV/NTL160110/6	160 x 110	6	86	61	177	T	63.200 *
FPV/NTL160110/8	160 x 110	8	86	61	177	T	67.300
FPV/NTL160110/10	160 x 110	10	86	61	177	T	134.600
FPV/NTL160125/8	160 x 125	8	86	68.5	177	T	68.800
FPV/NTL160125/10	160 x 125	10	86	68.5	177	T	141.800
FPV/NTL160140/8	160 x 140	8	86	76	177	T	71.800
FPV/NTL160140/10	160 x 140	10	86	76	177	T	167.900
FPV/NTL180125/10	180 x 125	10	96	66	197	T	124.800
FPV/NTL180160/10	180 x 160	10	96	86	200	T	140.200
FPV/NTL200110/8	200 x 110	8	106	61	207	T	150.000
FPV/NTL200125/8	200 x 125	8	106	68.5	218	T	151.200
FPV/NTL200125/10	200 x 125	10	106	68.5	218	T	153.000
FPV/NTL200140/8	200 x 140	8	106	76	218	T	156.500
FPV/NTL200140/10	200 x 140	10	106	76	218	T	160.000
FPV/NTL200160/8	200 x 160	8	106	86	218	T	164.800
FPV/NTL200160/10	200 x 160	10	106	86	218	T	252.500
FPV/NTL200180/10	200 x 180	10	106	96	220	T	173.200
FPV/NTL225110/10	225 x 110	10	119	61	186	T	175.700
FPV/NTL225160/10	225 x 160	10	119	86	210	T	222.900
FPV/NTL250180/10	250 x 180	10	131	96	272.3	T	342.800
FPV/NTL250200/10	250 x 200	10	-	-	-	T	277.200
FPV/NTL250225/10	250 x 225	10	131	119	256	T	385.100
FPV/NTL280250/10	280 x 250	10	146	131	294	T	1.037.000
FPV/NTL315160/10	315 x 160	10	164.5	86	336	T	1.105.000
FPV/NTL315200/10	315 x 200	10	164.5	106	336	T	1.105.000
FPV/NTL315250/10	315 x 250	10	164.5	131	336	T	1.105.000
FPV/NTL315280/10	315 x 280	10	164.5	147	338	T	1.827.000
FPV/NTL355200/10	355 x 200	10	184	106	360	T	2.984.000
FPV/NTL355225/10	355 x 225	10	184	119	360	T	3.362.000
FPV/NTL355250/10	355 x 250	10	184	164.5	360	T	3.362.000
FPV/NTL400200/10	400 x 200	10	206	106	422	T	3.274.000
FPV/NTL400250/10	400 x 250	10	206	131	422	T	3.463.000
FPV/NTL400315/10	400 x 315	10	206	164	422	T	3.651.000
FPV/NTL400355/10	400 x 355	10	206	184	422	T	4.507.000

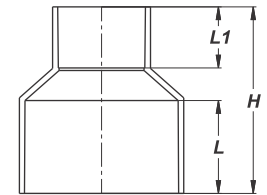

Kiểu T

 Mã trên là mã sản phẩm màu ghi. Muốn đặt sản phẩm màu trắng thêm **WH** vào cuối. VD: Mã **FPV/T75/8** sẽ thành **FPV/T75/8/WH**



**Y đều 45° - Equal Pieces 45°**

Mã số Code	Kích cỡ Size	PN (Bar)	L	Z	Z2	H	Kiểu dáng Shape	Đơn giá Unit Price (VND/cái)
FPV/Y34/10	34	10	29	43	8	109	G	<b>5.900</b>
FPV/Y42/10	42	10	31	53	9	124	G	<b>8.400</b>
FPV/Y48/10	48	10	34	63.5	10	142	G	<b>16.000</b>
FPV/Y60/8	60	8	40	80	19	179	T	<b>21.600</b>
FPV/Y60/10	60	10	41	75	14	170	G	<b>28.800</b>
FPV/Y75/8	75	8	51	94	18	214	G	<b>41.600</b>
FPV/Y75/12.5	75	12.5	66	95	21	248	G	<b>52.200</b>
FPV/Y90/8	90	8	58	115	19	251	G	<b>50.800</b>
FPV/Y90/12.5	90	12.5	70	114	25	279	G	<b>75.600</b>
FPV/Y110/8	110	8	61	137	25	283	G	<b>76.800</b>
FPV/Y110/12.5	110	12.5	73	140	30	316	G	<b>115.700</b>
FPV/Y125/8	125	8	68.5	160	35	332	G	<b>151.200</b>
FPV/Y125/12.5	125	12.5	76	159.5	36.5	348	G	<b>236.200</b>
FPV/Y140/8	140	8	72	174	32	348	G	<b>244.800</b>
FPV/Y140/12.5	140	12.5	80	178	37	375	G	<b>372.100</b>
FPV/Y160/10	160	10	77	198	37	388	G	<b>348.500</b>
FPV/Y160/12.5	160	12.5	90	203.5	43.5	427	G	<b>524.500</b>
FPV/Y180/10	180	10	105	232	56	498	G	<b>519.800</b>
FPV/Y200/8	200	8	106	250	52	524	G	<b>720.500</b>
FPV/Y200/10	200	10	115	252	52	534	G	<b>992.100</b>
FPV/Y225/10	225	10	118.5	284.7	77	599	G	<b>1.158.000</b>
FPV/Y250/10	250	10	131	315	87	664	G	<b>2.120.000</b>
FPV/Y280/8	280	8	146	354	96	742	G	<b>2.411.000</b>
FPV/Y315/8	315	8	163.5	394	93	845.5	G	<b>2.590.000</b>

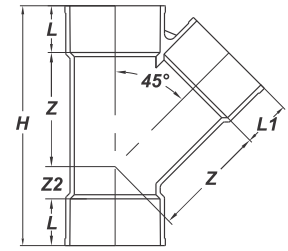
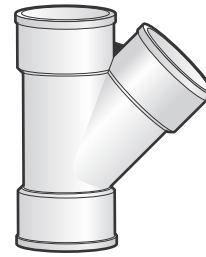

Kiểu G

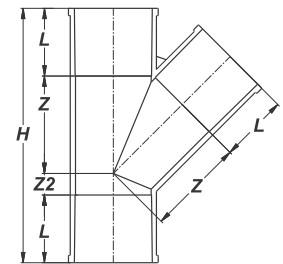
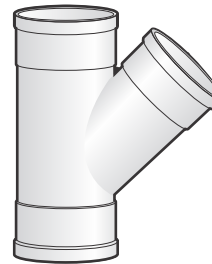

Kiểu G

**Y thu 45° - Reducing Y Pieces 45°**

Mã số Code	Kích cỡ Size	PN (Bar)	L	Z	L1	Z1	H	Kiểu dáng Shape	Đơn giá Unit Price (VND/cái)
FPV/YT4834/10	48 x 34	10	34	50	29	52	119	G	9.000
FPV/YT6034/10	60 x 34	10	41	58.3	29	68	139	G	12.200
FPV/YT6042/12.5	60 x 42	12.5	63	63	45	67	191	G	18.100
FPV/YT6048/10	60 x 48	10	48	68.5	42	71	172	G	14.300
FPV/YT7534/10	75 x 34	10	51	65.3	29	70.4	156	G	24.500
FPV/YT7542/10	75 x 42	10	51	71.7	31	74.6	169	G	25.600
FPV/YT7548/10	75 x 48	10	51	78.1	34	81.9	177	G	27.100
FPV/YT7560/10	75 x 60	10	51	86	48	87.5	200	G	36.800
FPV/YT7560/12.5	75 x 60	12.5	66	84	63	86.5	226	G	36.800
FPV/YT9034/10	90 x 34	10	58	82.4	29	83.5	179	G	32.000
FPV/YT9042/10	90 x 42	10	58	87.5	31	87.8	190	G	30.900
FPV/YT9048/8	90 x 48	8	58	89.9	34	94	194	G	31.500
FPV/YT9048/12.5	90 x 48	12.5	70	84.5	55	90	220	G	48.500
FPV/YT9060/10	90 x 60	10	59	94	48	99.5	216	G	39.800
FPV/YT9075/10	90 x 75	10	59	103.7	53	106.5	237	G	49.600
FPV/YT11048/8	110 x 48	8	61	96.3	34	107.5	198	G	48.200
FPV/YT11048/12.5	110 x 48	12.5	73	96	55	108	227	G	67.900
FPV/YT11060/10	110 x 60	10	61	103.8	48	114	220	G	54.100
FPV/YT11060/12.5	110 x 60	12.5	73	104	63	114	245	G	71.900
FPV/YT11075/10	110 x 75	10	61	111	51	122.1	232.6	G	68.500
FPV/YT11090/10	110 x 90	10	61	126.7	59	130	265	G	72.800
FPV/YT11090/12.5	110 x 90	12.5	73	126	70	129	288	G	80.500
FPV/YT12548/10	125 x 48	10	68.5	104	42	121.6	220	G	74.100
FPV/YT12548/12.5	125 x 48	12.5	76	105	55	121	237	G	94.800
FPV/YT12560/10	125 x 60	10	68.5	114.3	48	126.5	240	G	77.800
FPV/YT12575/10	125 x 75	10	68.5	123.7	53	135	260	G	98.000
FPV/YT12575/12.5	125 x 75	12.5	76	123	66	134	274	G	153.600
FPV/YT12590/10	125 x 90	10	68.5	153.2	59	141.5	280	G	106.600
FPV/YT12590/12.5	125 x 90	12.5	76	133.5	70	141	295	G	112.800
FPV/YT125110/12.5	125 x 110	12.5	76	148	73	151	323	G	123.100
FPV/YT14090/10	140 x 90	10	76	142.7	59	153.5	302	G	155.900
FPV/YT14090/12.5	140 x 90	12.5	80	142.5	70	153	305	G	231.600
FPV/YT140110/8	140 x 110	8	72	148.7	61	158.8	302.8	G	165.200
FPV/YT140110/12.5	140 x 110	12.5	80	156.5	73	163	334	G	263.300
FPV/YT16090/10	160 x 90	10	86	153.7	59	167.3	325	G	173.000
FPV/YT160110/10	160 x 110	10	77	161.7	61	172	317	G	302.500
FPV/YT160110/12.5	160 x 110	12.5	90	168	73	178.5	356	G	346.000
FPV/YT160125/12.5	160 x 125	12.5	90	178.5	76	186	377	G	310.500
FPV/YT160140/10	160 x 140	10	77	186.2	72	188.5	362	G	268.600
FPV/YT20090/10	200 x 90	10	106	176.7	59	197.5	365	G	380.200
FPV/YT20090/12.5	200 x 90	12.5	115	174	70	197	378	G	559.500
FPV/YT200110/10	200 x 110	10	106	190.8	61	207.5	392	G	422.800
FPV/YT200110/12.5	200 x 110	12.5	115	188	73	207	406	G	447.600
FPV/YT200125/10	200 x 125	10	106	200.5	68.5	216	415	G	461.800
FPV/YT200125/12.5	200 x 125	12.5	115	198	76	214	427	G	484.800
FPV/YT200140/10	200 x 140	10	106	210.7	76	223.4	435	G	488.900
FPV/YT200160/10	200 x 160	10	106	225.3	86	233.5	465	G	513.900
FPV/YT225160/10	225 x 160	10	118.5	238.7	86	252.5	495	G	850.300
FPV/YT250125/10	250 x 125	10	131	229.5	68.5	252.8	470	G	850.300
FPV/YT250160/10	250 x 160	10	131	253.2	86	269.3	520	G	850.300
FPV/YT250200/10	250 x 200	10	131	282.5	106	291.3	575	G	910.000

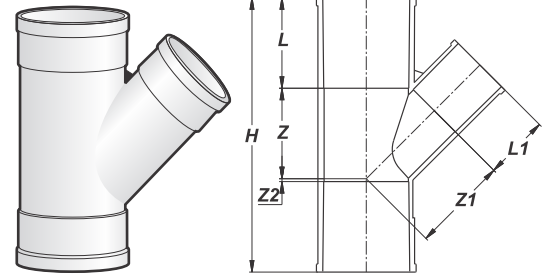
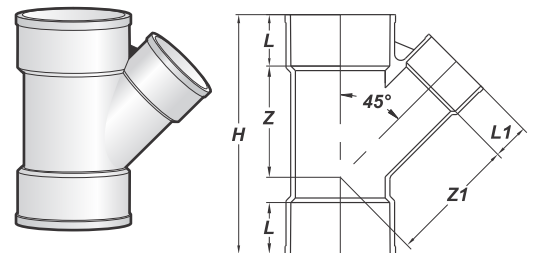
**Kiểu G**

**Kiểu G**

Mã trên là mã sản phẩm màu ghi. Muốn đặt sản phẩm màu trắng thêm **WH** vào cuối. VD: Mã **FPV/T75/8** sẽ thành **FPV/T75/8/WH**

**Tê 90° loại phổ thông - Normal Tee 90°**

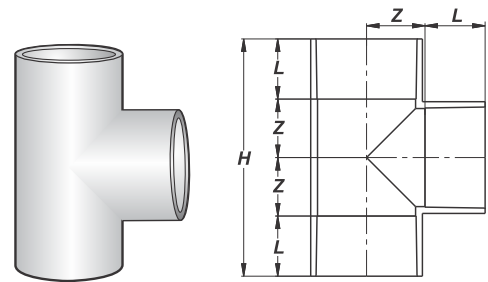
Mã số Code	Kích cỡ Size	PN (Bar)	L	Z	H	Kiểu dáng Shape	Đơn giá Unit Price (VND/cái)
FPV/TV21/PT/10	21	10	17	11	55.5	T	<b>2.200</b>
FPV/TV21/PT/16	21	16	30	13	55.5	T	<b>4.300</b>
FPV/TV27/PT/10	27	10	20	14.5	69	T	<b>3.900</b>
FPV/TV27/PT/16	27	16	35	16.5	69	T	<b>5.500</b>
FPV/TV34/PT/12.5	34	12.5	23	18.8	83.6	T	<b>5.600</b>
FPV/TV34/PT/16	34	16	22	19.5	84	T	<b>9.300</b>
FPV/TV42/PT/10	42	10	27	22.7	99.4	T	<b>7.500</b>
FPV/TV42/PT/16	42	16	45	24	-	T	<b>15.700</b>
FPV/TV48/PT/10	48	10	30	26	112	T	<b>11.100</b>
FPV/TV48/PT/16	48	16	55	27	-	T	<b>22.500</b>
FPV/TV60/PT/8	60	8	36	32.9	137.8	T	<b>17.500</b>
FPV/TV60/PT/16	60	16	59	35	-	T	<b>34.600</b>
FPV/TV75/PT/6	75	6	43.5	40	167	T	<b>28.200 *</b>
FPV/TV75/PT/8	75	8	44	41.8	171.6	T	<b>29.800</b>
FPV/TV90/PT/6	90	6	51	48	198	T	<b>38.500 *</b>
FPV/TV90/PT/8	90	8	51	49.2	200	T	<b>41.000</b>
FPV/TV110/PT/6	110	6	61	58	238	T	<b>65.500 *</b>
FPV/TV110/PT/8	110	8	61	59.5	241	T	<b>70.000</b>
FPV/TV125/PT/6	125	6	69	-	271	T	<b>115.100</b>
FPV/TV125/PT/10	125	10	69	67.5	273	T	<b>145.200</b>
FPV/TV140/PT/6	140	6	76	72	296	T	<b>186.600 *</b>
FPV/TV180/PT/10	180	10	105	106	423	T	<b>589.200</b>
FPV/TV200/PT/6	200	6	106	105	422	T	<b>466.600 *</b>
FPV/TV200/PT/8	200	8	106	105	422	T	<b>530.500 *</b>
FPV/TV200/PT/10	200	10	-	-	-	T	<b>583.600</b>
FPV/TV225/PT/10	225	10	119	115	468	T	<b>894.100</b>
FPV/TV250/PT/10	250	10	131	128	518	T	<b>1.547.800</b>
FPV/TV280/PT/10	280	10	147	149	592	T	<b>6.579.000</b>
FPV/TV315/PT/6	315	6	-	-	-	T	<b>1.772.000</b>
FPV/TV315/PT/10	315	10	164	161.5	651	T	<b>7.730.000</b>
FPV/TV355/PT/10	355	10	184	185.5	739	T	<b>11.450.000</b>
FPV/TV400/PT/10	400	10	186	210	792	T	<b>11.946.000</b>



Kiểu T

**Tê thu 90° - Reducing Tee 90°**

Mã số Code	Kích cỡ Size	PN (Bar)	H	h1	h2	Z	Kiểu dạng Shape	Đơn giá Unit Price (VND/cái)
FPV/TT6034/8	60 x 34	8	110	36	23	55	T	12.500 *
FPV/TT6042/8	60 x 42	8					T	
FPV/TT6048/8	60 x 48	8					T	
FPV/TT7542/8	75 x 42	8					T	
FPV/TT7548/8	75 x 48	8	139	43.5	30	70	T	23.000 *
FPV/TT7560/8	75 x 60	8	151	43.5	36	76	T	25.800 *
FPV/TT9048/6	90 x 48	6					T	
FPV/TT9060/6	90 x 60	6	166	51	36	84	T	38.500 *
FPV/TT9075/6	90 x 75	6	182	51	43.5	91.5	T	40.500 *
FPV/TT11060/6	110 x 60	6	186	61	36	94	T	46.800 *
FPV/TT11075/6	110 x 75	6	202	61	43.5	101.5	T	48.500 *
FPV/TT11090/6	110 x 90	6	202	61	43.5	101.5	T	58.100 *
FPV/TT14090/6	140 x 90	6	264	76	51	132	T	114.000 *
FPV/TT140110/6	140 x 110	6	284	76	61	142	T	125.200 *
FPV/TT16090/6	160 x 90	6	290	86	51	142	T	159.500 *
FPV/TT160110/6	160 x 110	6	310	86	61	152	T	170.500 *
FPV/TT225110/10	225 x 110	10	359.5	119	61	191	T	1.362.000
FPV/TT225160/10	225 x 160	10	406.5	119	86	213	T	1.559.000
FPV/TT250110/10	250 x 110	10	378	131	61	189	T	1.290.000
FPV/TT250160/10	250 x 160	10	428.5	131	86	223.5	T	1.448.000
FPV/TT250200/10	250 x 200	10	468.5	131	106	233.5	T	1.614.000
FPV/TT280200/10	280 x 200	10	512	147	106	255	T	4.414.000
FPV/TT315110/10	315 x 110	10	447.5	164	61	223	T	4.836.000
FPV/TT315160/10	315 x 160	10	497.5	164	86	248	T	4.993.000
FPV/TT315200/10	315 x 200	10	537	164	106	268	T	5.150.000
FPV/TT315225/10	315 x 225	10	557	164	119	277	T	5.975.000
FPV/TT315250/10	315 x 250	10	587	164	131	293	T	5.803.000
FPV/TT355160/10	355 x 160	10	530	184	86	265	T	8.827.000
FPV/TT355200/10	355 x 200	10	572	184	106	285	T	9.985.000
FPV/TT355225/10	355 x 225	10	595	184	119	298	T	10.162.000
FPV/TT355250/10	355 x 250	10	621	184	131	310	T	10.338.000
FPV/TT400200/10	400 x 200	10	644	206	106	316	T	10.911.000
FPV/TT400225/10	400 x 225	10	640	206	119	322	T	11.285.000
FPV/TT400250/10	400 x 250	10	751	206	131	341	T	11.457.000
FPV/TT400315/10	400 x 315	10	751	206	164	374	T	11.629.000

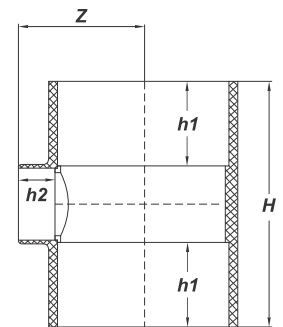
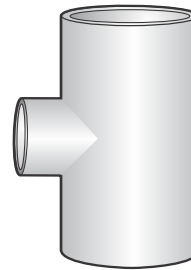

Kiểu T

 Mã trên là mã sản phẩm màu ghi. Muốn đặt sản phẩm màu trắng thêm **WH** vào cuối. VD: Mã **FPV/T75/8** sẽ thành **FPV/T75/8/WH**

**PHỤ KIỆN U-PVC HÀN - PHỤ NỮ**
**Nối góc hàn 45° - Elbow 45°**

Mã số Code	Kích cỡ Size	PN (Bar)	L <sub>min</sub>	Z <sub>min</sub>	Đơn giá Unit Price (VND/cái)
FPV/CHH225/5	225	5	150	125	<b>1.055.000</b>
FPV/CHH280/5	280	5	146	88	<b>1.314.000</b>
FPV/CHH315/5	315	5	180	160	<b>1.479.000</b>
FPV/CHH355/5	355	5	190	170	<b>1.666.000</b>
FPV/CHH400/5	400	5	206	123	<b>1.877.000</b>
FPV/CHH450/5	450	5	231	133	<b>2.111.000</b>

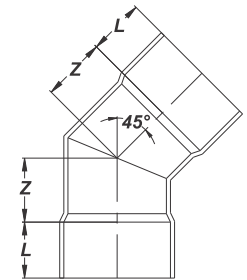
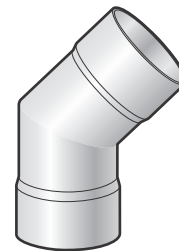
**Nối góc hàn 90° - Elbow 90°**

Mã số Code	Kích cỡ Size	PN (Bar)	L <sub>min</sub>	Z <sub>min</sub>	Đơn giá Unit Price (VND/cái)
FPV/GVH200/5	200	5	106	148	<b>739.000</b>
FPV/GVH225/5	225	5	150	125	<b>830.000</b>
FPV/GVH250/5	250	5	131	163	<b>923.000</b>
FPV/GVH280/5	280	5	180	165	<b>1.023.000</b>
FPV/GVH315/5	315	5	190	170	<b>1.775.000</b>
FPV/GVH355/5	355	5	183	234	<b>2.000.000</b>
FPV/GVH400/5	400	5	206	265	<b>2.253.000</b>
FPV/GVH450/5	450	5	231	290	<b>2.534.000</b>

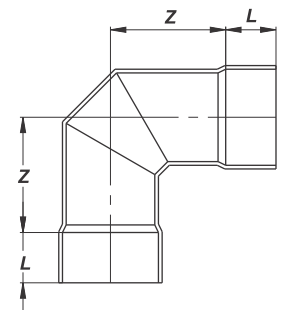
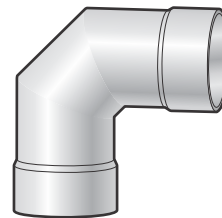
**Tê hàn 90° - Tee 90°**

Mã số Code	Kích cỡ Size	PN (Bar)	L <sub>min</sub>	Z <sub>min</sub>	Đơn giá Unit Price (VND/cái)
FPV/TVH200/5	200	5	130	145	<b>1.126.000</b>
FPV/TVH225/5	225	5	118	142	<b>1.268.000</b>
FPV/TVH250/5	250	5	170	188	<b>1.408.000</b>
FPV/TVH280/5	280	5	146	170	<b>1.577.000</b>
FPV/TVH315/5	315	5	190	260	<b>1.825.000</b>
FPV/TVH355/5	355	5	183	212	<b>2.055.000</b>
FPV/TVH400/5	400	5	206	240	<b>2.315.000</b>
FPV/TVH450/5	450	5	231	265	<b>2.602.000</b>

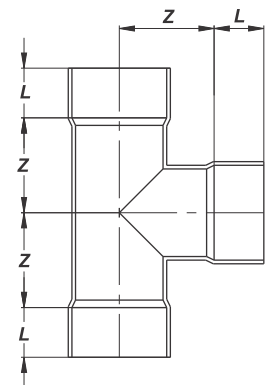
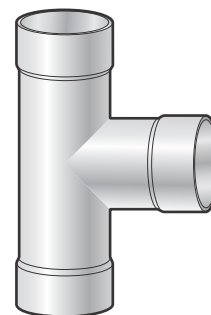

**Nối góc hàn phủ 45° - Elbow 45°**

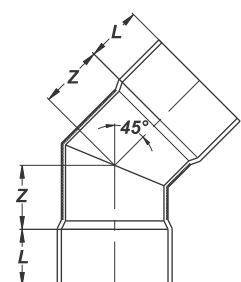
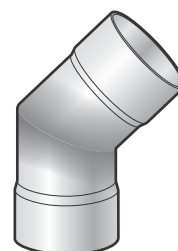
Mã số Code	Kích cỡ Size	PN (Bar)	L <sub>min</sub>	Z <sub>min</sub>	Đơn giá Unit Price (VND/cái)
FPV/CHHP200/8	200	8	106	71	<b>1.218.000</b>
FPV/CHHP225/8	225	8	150	125	<b>1.372.000</b>
FPV/CHHP250/8	250	8	131	82	<b>1.522.000</b>
FPV/CHHP280/8	280	8	180	165	<b>1.708.000</b>
FPV/CHHP315/8	315	8	190	170	<b>1.922.000</b>
FPV/CHHP355/8	355	8	183	108	<b>2.166.000</b>
FPV/CHHP400/8	400	8	206	123	<b>2.440.000</b>
FPV/CHHP450/8	450	8	231	133	<b>2.745.000</b>

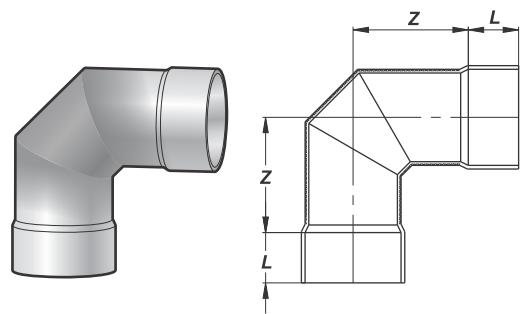

**Nối góc hàn phủ 90° - Elbow 90°**

Mã số Code	Kích cỡ Size	PN (Bar)	L <sub>min</sub>	Z <sub>min</sub>	Đơn giá Unit Price (VND/cái)
FPV/GVHP200/8	200	8	106	148	<b>960.000</b>
FPV/GVHP225/8	225	8	150	125	<b>1.078.000</b>
FPV/GVHP250/8	250	8	131	163	<b>1.200.000</b>
FPV/GVHP280/8	280	8	180	165	<b>1.342.000</b>
FPV/GVHP315/8	315	8	190	170	<b>2.308.000</b>
FPV/GVHP355/8	355	8	183	234	<b>2.600.000</b>
FPV/GVHP400/8	400	8	206	265	<b>2.928.000</b>
FPV/GVHP450/8	450	8	231	290	<b>3.295.000</b>

**Tê hàn phủ 90° - Tee 90°**

Mã số Code	Kích cỡ Size	PN (Bar)	L <sub>min</sub>	Z <sub>min</sub>	Đơn giá Unit Price (VND/cái)
FPV/TVHP200/8	200	8	130	110	<b>1.465.000</b>
FPV/TVHP225/8	225	8	150	118	<b>1.648.000</b>
FPV/TVHP250/8	250	8	165	150	<b>1.830.000</b>
FPV/TVHP280/8	280	8	180	140	<b>2.050.000</b>
FPV/TVHP315/8	315	8	190	178	<b>2.372.000</b>
FPV/TVHP355/8	355	8	183	212	<b>2.672.000</b>
FPV/TVHP400/8	400	8	206	240	<b>3.010.000</b>
FPV/TVHP450/8	450	8	231	265	<b>3.382.000</b>

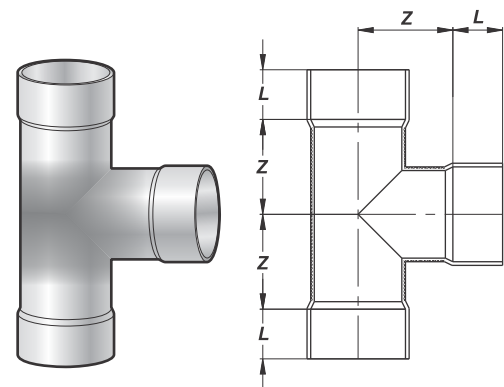
**Tê thu hàn phủ 90° - Reducing Tee 90°**

Mã số Code	Kích cỡ Size	PN (Bar)	L	L1	h	h1	Đơn giá Unit Price (VND/cái)
FPV/TTHP225200/8	225 x 200	8	150	130	520	258.3	<b>902.000</b>
FPV/TTHP250200/8	250 x 200	8	165	130	555	280	<b>1.178.000</b>
FPV/TTHP250225/8	250 x 225	8	165	150	580	290	<b>1.376.000</b>
FPV/TTHP280200/8	280 x 200	8	180	130	585	295.8	<b>1.688.000</b>
FPV/TTHP280225/8	280 x 225	8	180	150	620	300.8	<b>1.806.000</b>
FPV/TTHP280250/8	280 x 250	8	180	165	635	310.8	<b>1.962.000</b>
FPV/TTHP315200/8	315 x 200	8	190	130	610	327.5	<b>2.158.000</b>
FPV/TTHP315225/8	315 x 225	8	190	150	625	337.5	<b>2.356.000</b>
FPV/TTHP315250/8	315 x 250	8	190	165	650	352.5	<b>2.480.000</b>
FPV/TTHP315280/8	315 x 280	8	190	180	672	357.5	<b>2.556.000</b>

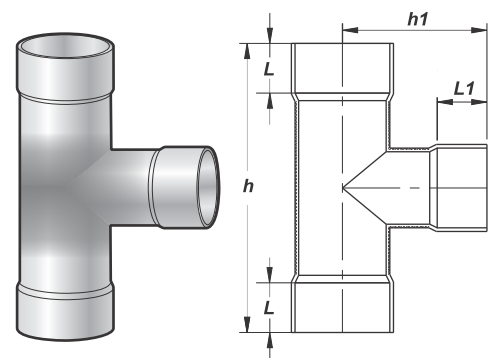
**Y thu 45° hàn phủ - Reducing Y Pieces 45°**

Mã số Code	Kích cỡ Size	PN (Bar)	L	L1	H	Đơn giá Unit Price (VND/cái)
FPV/YTHP315200/8	315 x 200	8	180	140	730	<b>2.590.000</b>
FPV/YTHP315250/8	315 x 250	8	180	160	820	<b>2.590.000</b>

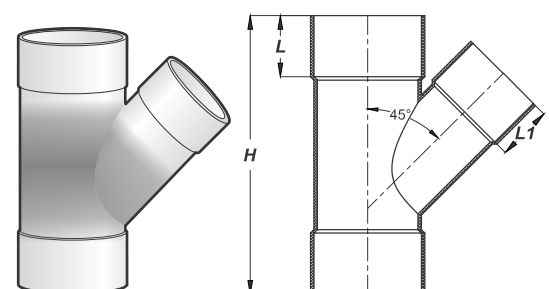

Mã trên là mã sản phẩm màu ghi. Muốn đặt sản phẩm màu trắng thêm **WH** vào cuối. VD: Mã **FPV/T75/8** sẽ thành **FPV/T75/8/WH**

**Thập đều hàn phủ - Equal Cross**

Mã số Code	Kích cỡ Size	PN (Bar)	L	Z	H	Đơn giá Unit Price (VND/cái)
FPV/THHP90/12.5	90	12.5	79	85	328	<b>490.000</b>
FPV/THHP110/12.5	110	12.5	91	95	372	<b>576.000</b>
FPV/THHP125/12.5	125	12.5	100	103	406	<b>756.000</b>
FPV/THHP140/12.5	140	12.5	109	110	438	<b>936.000</b>
FPV/THHP160/12.5	160	12.5	121	120	482	<b>1.125.000</b>
FPV/THHP200/12.5	200	12.5	145	140	570	<b>1.350.000</b>
FPV/THHP250	250					<b>3.500.000</b>

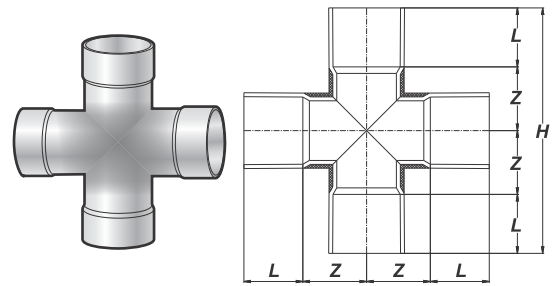
**Nối góc uốn phủ 45° - Bends 18°**

Mã số Code	Kích cỡ Size	PN (Bar)	L	Đơn giá Unit Price (VND/cái)
FPV/CHUP315/10	315	10	210	<b>2.510.000</b>

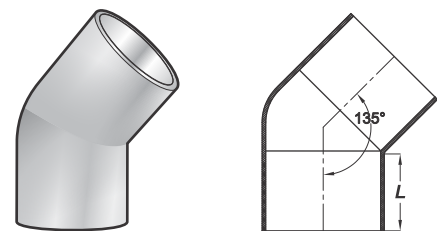
**Nối thu đồng tâm nông phủ - Reducing Pipe Coupling**

Mã số Code	Kích cỡ Size	PN (Bar)	L	L1	H	Đơn giá Unit Price (VND/cái)
FPV/NTLNP315200/10	315 x 200	8	180	140	395	<b>1.105.000</b>
FPV/NTLNP315250/10	315 x 250	8	180	165	410	<b>1.105.000</b>

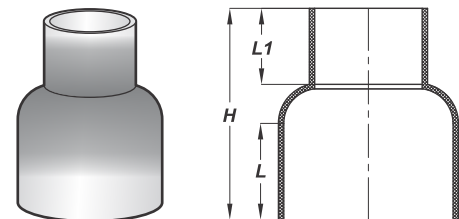

**Nối góc 91.5° phun phủ - Elbow 91.5°**

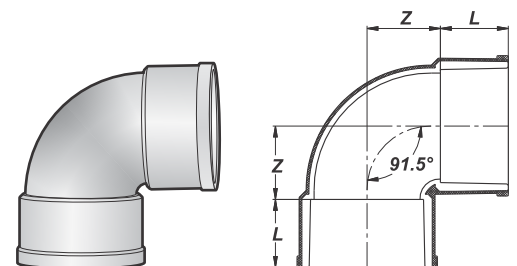
Mã số Code	Kích cỡ Size	PN (Bar)	L	Z	Đơn giá Unit Price (VND/cái)
FPV/GPP110/16	110	16	61	65	<b>142.000</b>
FPV/GPP140/16	140	16	72	80	<b>292.000</b>
FPV/GPP160/16	160	16	77	90	<b>367.000</b>
FPV/GPP200/16	200	16	82	116	<b>888.000</b>
FPV/GPP250/16	250	16	88	145	<b>1.116.000</b>

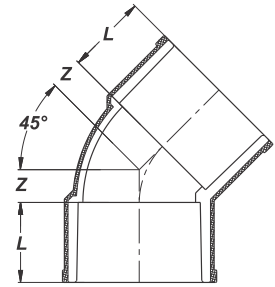
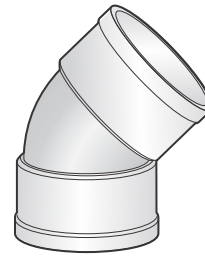

**Nối góc 45° phun phủ - Elbow 45°**

Mã số Code	Kích cỡ Size	PN (Bar)	L	Z	Đơn giá Unit Price (VND/cái)
FPV/CHPP110/16	110	16	61	25	<b>106.000</b>
FPV/CHPP125/16	125	16	69	28.5	<b>190.000</b>
FPV/CHPP140/16	140	16	72	32	<b>274.000</b>
FPV/CHPP160/16	160	16	77	36	<b>400.000</b>
FPV/CHPP200/16	200	16	82	47	<b>848.000</b>
FPV/CHPP250/16	250	16	88	60	<b>1.064.000</b>

**Nối thẳng phun phủ - Coupling**

Mã số Code	Kích cỡ Size	PN (Bar)	L	Z	H	Đơn giá Unit Price (VND/cái)
FPV/NPP160/12.5	160	12.5	77	3.5	141.5	<b>171.000</b>
FPV/NPP200/12.5	200	12.5	82	3.5	167.5	<b>360.000</b>
FPV/NPP250/12.5	250	12.5	95	3.0	193	<b>475.000</b>

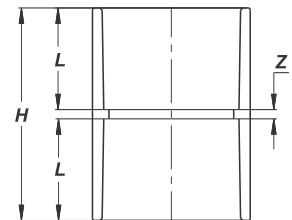
**Y đều 45° phun phủ - Equal Pieces 45°**

Mã số Code	Kích cỡ Size	PN (Bar)	L	Z	Z1	H	Đơn giá Unit Price (VND/cái)
FPV/YPP110/16	110	16	73	140	30	316	<b>196.000</b>
FPV/YPP125/16	125	16	76	159.5	36.5	348	<b>410.000</b>
FPV/YPP140/16	140	16	80	178	37	375	<b>624.000</b>
FPV/YPP160/16	160	16	90	203.5	43.5	427	<b>860.000</b>
FPV/YPP200/16	200	16	115	252	52	534	<b>1.445.000</b>

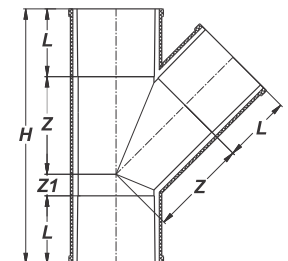
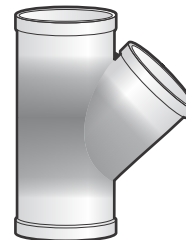
**Y thu 45° phun phủ - Reducing Y Pieces 45°**

Mã số Code	Kích cỡ Size	PN (Bar)	L	Z	L1	Z1	H	Đơn giá Unit Price (VND/cái)
FPV/YTPP11090/16	110 x 90	16	73	126	70	129	288	<b>242.000</b>
FPV/YTPP12548/16	125 x 48	16	76	105	55	121	237	<b>352.000</b>
FPV/YTPP12575/16	125 x 75	16	76	123	66	134	274	<b>364.000</b>
FPV/YTPP12590/16	125 x 90	16	76	133.5	70	141	295	<b>364.000</b>
FPV/YTPP125110/16	125 x 110	16	76	148	73	151	323	<b>364.000</b>
FPV/YTPP14090/16	140 x 90	16	80	142.5	70	153	305	<b>508.000</b>
FPV/YTPP140110/16	140 x 110	16	80	156.5	73	163	334	<b>508.000</b>
FPV/YTPP160110/16	160 x 110	16	90	168	73	178.5	356	<b>588.000</b>
FPV/YTPP160125/16	160 x 125	16	90	178.5	76	186	377	<b>588.000</b>
FPV/YTPP20090/16	200 x 90	16	115	174	70	197	378	<b>956.000</b>
FPV/YTPP200110/16	200 x 110	16	115	188	73	207	406	<b>956.000</b>
FPV/YTPP200125/16	200 x 125	16	115	198	76	214	427	<b>956.000</b>

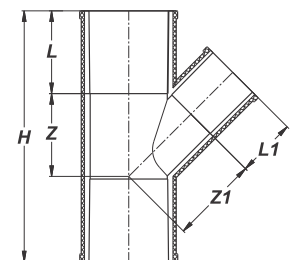
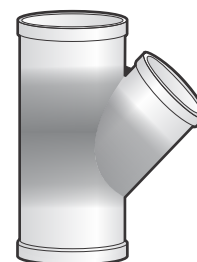

Mã trên là mã sản phẩm màu ghi. Muốn đặt sản phẩm màu trắng thêm **WH** vào cuối. VD: Mã **FPV/T75/8** sẽ thành **FPV/T75/8/WH**



**Tê 91.5° phun phủ - Tee 91.5°**

Mã số Code	Kích cỡ Size	PN (Bar)	L	Z	Z1	Z2	R	H	Đơn giá Unit Price (VND/cái)
<b>FPV/TPP110/16</b>	110	16	61	55	68	65	34	242	<b>191.200</b>
<b>FPV/TPP140/16</b>	140	16	72	71	86	82	26	296	<b>476.000</b>
<b>FPV/TPP160/16</b>	160	16	77	82	96	90	20	327	<b>520.000</b>

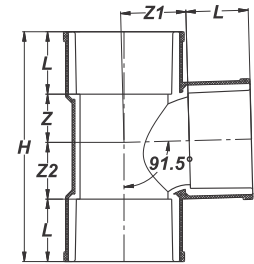
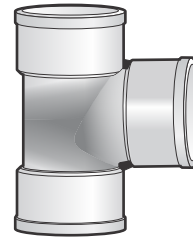
**Tê thu 91.5° phun phủ - Reducing Tee 91.5°**

Mã số Code	Kích cỡ Size	PN (Bar)	L	Z	L1	Z1	Z2	H	Đơn giá Unit Price (VND/cái)
<b>FPV/TTPP11090/16</b>	110 x 90	16	61	43.7	58	67.2	55.2	223	<b>222.400</b>
<b>FPV/TTPP14090/16</b>	140 x 90	16	72	43.7	58	67.2	55.2	253.5	<b>472.000</b>
<b>FPV/TTPP140110/16</b>	140 x 110	16	72	43.7	61	67.2	55.2	275	<b>472.000</b>
<b>FPV/TTPP16090/16</b>	160 x 90	16							<b>504.000</b>
<b>FPV/TTPP160110/16</b>	160 x 110	16	77	56.7	61	94.4	64.6	275.5	<b>504.000</b>
<b>FPV/TTPP160125/16</b>	160 x 125	16							<b>504.000</b>
<b>FPV/TTPP200110/16</b>	200 x 110	16	82	58.7	61	133	89	318	<b>1.432.000</b>
<b>FPV/TTPP200160/16</b>	200 x 160	16	82	83.6	77	135.1	115.6	340	<b>1.432.000</b>

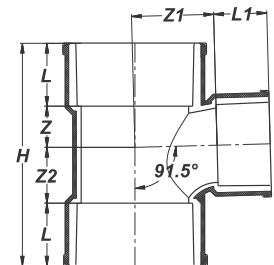
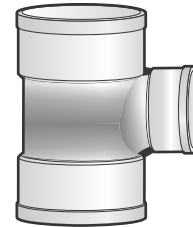

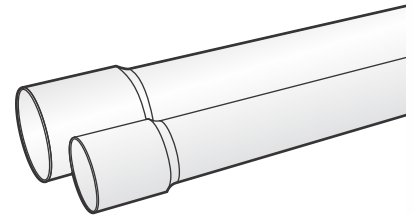
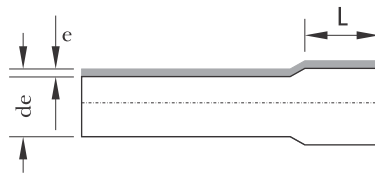
**ỐNG u-PVC HỆ INCH**

**Ống u.PVC hệ Inch - Inch Pipes**

Mã số Code	Đường kính de	e	Đơn giá Unit Price (VND/m)
PV/2112/INC	Ø21	1.2	7.500
PV/2116/INC	Ø21	1.6	9.800
PV/2130/INC	Ø21	3.0	16.200
PV/2715/INC	Ø27	1.5	11.100
PV/2718/INC	Ø27	1.8	13.600
PV/2730/INC	Ø27	3.0	21.300
PV/3419/INC	Ø34	1.9	18.500
PV/3421/INC	Ø34	2.1	19.100
PV/3430/INC	Ø34	3.0	27.100
PV/4218/INC	Ø42	1.8	20.900
PV/4221/INC	Ø42	2.1	25.300
PV/4918/INC	Ø49	1.8	27.500
PV/4925/INC	Ø49	2.5	33.100
PV/6020/INC	Ø60	2.0	35.100
PV/6023/INC	Ø60	2.3	39.500
PV/6025/INC	Ø60	2.5	48.500
PV/7618/INC	Ø76	1.8	40.500
PV/7622/INC	Ø76	2.2	55.000
PV/9020/INC	Ø90	2.0	54.100
PV/9026/INC	Ø90	2.6	67.100
PV/9029/INC	Ø90	2.9	75.800
PV/11429/INC	Ø114	2.9	95.300
PV/11435/INC	Ø114	3.5	120.000

Mã trên là mã sản phẩm màu ghi. Muốn đặt sản phẩm màu trắng thêm **WH** vào cuối. VD: Mã **FPV/Y60M/INC** sẽ thành **FPV/Y60M/INC/WH**

**PHỤ KIỆN u-PVC HỆ INCH**
**Nối góc 45° - Elbow 45°**

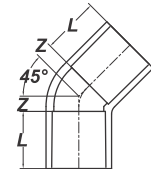
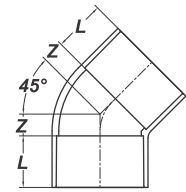
Mã số Code	Kích cỡ Size	L	Z	Đơn giá Unit Price (VND/cái)
<b>Loại phổ thông - Thin fittings</b>				
FPV/CH60M/INC	60	40	15.5	<b>8.100</b>
FPV/CH76M/INC	76	45	19	<b>15.300</b>
FPV/CH90M/INC	90	51	22.5	<b>19.800</b>
FPV/CH114M/INC	114	64	28.5	<b>37.200</b>
<b>Loại áp lực cao - Thick fittings</b>				
FPV/CH21D/INC	21	30	7	<b>2.900</b>
FPV/CH27D/INC	27	35	8	<b>4.300</b>
FPV/CH34D/INC	34	40	10	<b>6.900</b>
FPV/CH42D/INC	42	45	12	<b>9.800</b>
FPV/CH49D/INC	49	55	13	<b>14.900</b>
FPV/CH60D/INC	60	60	18	<b>22.900</b>

**Nối góc 90° - Elbow 90°**

Mã số Code	Kích cỡ Size	L	Z	Đơn giá Unit Price (VND/cái)
<b>Loại phổ thông - Thin fittings</b>				
FPV/GV60M/INC	60	40	34	<b>11.000</b>
FPV/GV76M/INC	76	45	41	<b>17.800</b>
FPV/GV90M/INC	90	51	48.5	<b>24.500</b>
FPV/GV114M/INC	114	64	61.5	<b>52.800</b>
<b>Loại áp lực cao - Thick fittings</b>				
FPV/GV21D/INC	21	30	13	<b>3.300</b>
FPV/GV27D/INC	27	35	16	<b>5.300</b>
FPV/GV34D/INC	34	40	19.5	<b>7.500</b>
FPV/GV42D/INC	42	45	24	<b>11.200</b>
FPV/GV49D/INC	49	55	27	<b>17.800</b>
FPV/GV60D/INC	60	60	34	<b>28.300</b>

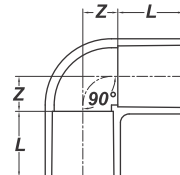
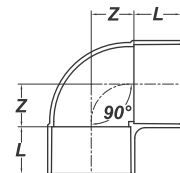
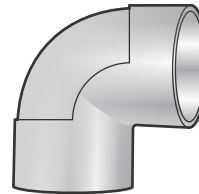

**Nối thẳng - Coupling**

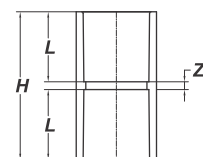
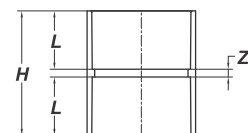
Mã số Code	Kích cỡ Size	L	Z	H	Đơn giá Unit Price (VND/cái)
<b>Loại phổ thông - Thin fittings</b>					
FPV/N60M/INC	60	40	6	86	<b>5.500</b>
FPV/N76M/INC	76	45	6	96	<b>8.300</b>
FPV/N90M/INC	90	51	6	108	<b>13.500</b>
FPV/N114M/INC	114	64	8	136	<b>25.300</b>
<b>Loại áp lực cao - Thick fittings</b>					
FPV/N21D/INC	21	30	4	64	<b>2.500</b>
FPV/N27D/INC	27	35	4	74	<b>3.500</b>
FPV/N34D/INC	34	40	4	84	<b>5.800</b>
FPV/N42D/INC	42	45	5	95	<b>8.000</b>
FPV/N49D/INC	49	55	6	116	<b>12.300</b>
FPV/N60D/INC	60	60	6	126	<b>19.000</b>

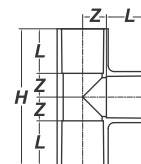
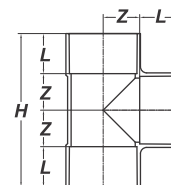
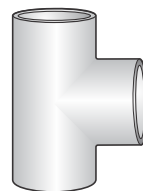

**Tê 90° - Tee 90°**

Mã số Code	Kích cỡ Size	L	Z	H	Đơn giá Unit Price (VND/cái)
<b>Loại phổ thông - Thin fittings</b>					
FPV/T60M/INC	60	40	34	148	<b>16.100</b>
FPV/T76M/INC	76	45	41	172	<b>24.300</b>
FPV/T90M/INC	90	51	48.5	199	<b>31.500</b>
FPV/T114M/INC	114	64	61.5	251	<b>67.000</b>
<b>Loại áp lực cao - Thick fittings</b>					
FPV/T21D/INC	21	30	13	86	<b>4.300</b>
FPV/T27D/INC	27	35	16.5	103	<b>7.000</b>
FPV/T34D/INC	34	40	19.5	119	<b>11.600</b>
FPV/T42D/INC	42	45	24	138	<b>15.200</b>
FPV/T49D/INC	49	55	27	164	<b>22.600</b>
FPV/T60D/INC	60	60	34	188	<b>38.600</b>

**Tê thu 90° - Reducing Pieces 90°**

Mã số Code	Kích cỡ Size	L	Z	L1	Z1	H	Đơn giá Unit Price (VND/cái)
<b>Loại phổ thông - Thin fittings</b>							
FPV/TT9034M/INC	90 x 34	51	22	40	48	146	<b>29.500</b>
FPV/TT9060M/INC	90 x 60	51	35	40	48	172	<b>29.600</b>
FPV/TT11460M/INC	114 x 60	64	35.5	40	61	199	<b>41.900</b>
FPV/TT11490M/INC	114 x 90	64	49.5	51	62	227	<b>65.100</b>
<b>Loại áp lực cao - Thick fittings</b>							
FPV/TT2721D/INC	27 x 21	35	13.5	30	15.5	97	<b>5.300</b>
FPV/TT3421D/INC	34 x 21	40	13.5	30	19	107	<b>8.100</b>
FPV/TT3427D/INC	34 x 27	40	16	35	19.5	112	<b>9.500</b>
FPV/TT4221D/INC	42 x 21	45	14	30	23.5	118	<b>11.600</b>
FPV/TT4227D/INC	42 x 27	45	16.5	35	24	123	<b>11.600</b>
FPV/TT4234D/INC	42 x 34	45	20	40	24	130	<b>12.900</b>
FPV/TT4921D/INC	49 x 21	55	14.5	30	26.5	139	<b>15.200</b>
FPV/TT4927D/INC	49 x 27	55	16.5	35	27	143	<b>16.500</b>
FPV/TT4934D/INC	49 x 34	55	20	40	27.5	150	<b>18.200</b>
FPV/TT4942D/INC	49 x 42	55	24	45	27	158	<b>20.300</b>
FPV/TT6021D/INC	60 x 21	60	15	30	32.5	150	<b>24.200</b>
FPV/TT6027D/INC	60 x 27	60	17.5	35	33	155	<b>26.800</b>
FPV/TT6034D/INC	60 x 34	60	21	40	33	162	<b>25.000</b>
FPV/TT6042D/INC	60 x 42	60	25	45	33.5	170	<b>28.100</b>
FPV/TT6049D/INC	60 x 49	60	28	55	33.5	176	<b>31.600</b>

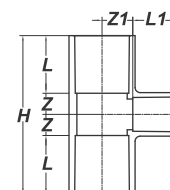
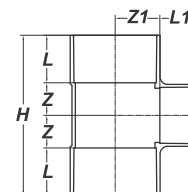
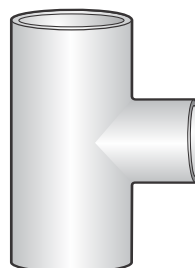
**Y đều 45° - Equal Pieces 45°**

Mã số Code	Kích cỡ Size	L	Z	Z2	H	Đơn giá Unit Price (VND/cái)
<b>Loại phổ thông - Thin fittings</b>						
FPV/Y60M/INC	60	40	80	18	178	<b>20.000</b>
FPV/Y76M/INC	76	45	99	21	210	<b>38.500</b>
FPV/Y90M/INC	90	51	117	25	244	<b>47.000</b>
FPV/Y114M/INC	114	64	148	31	307	<b>81.600</b>

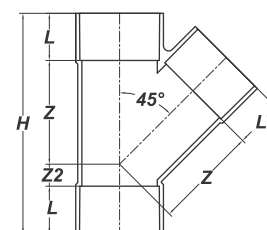
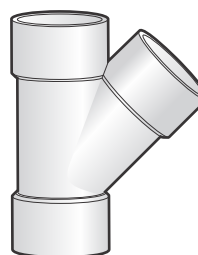

Mã trên là mã sản phẩm màu ghi. Muốn đặt sản phẩm màu trắng thêm **WH** vào cuối. VD: Mã **FPV/Y60M/INC** sẽ thành **FPV/Y60M/INC/WH**

**Zắc co - Socket unions**

Mã số Code	Kích cỡ Size	L	L1	H	Đơn giá Unit Price (VND/cái)
<b>Loại áp lực cao - Thick fittings</b>					
FPV/Z21D/INC	21	25.5	27.5	61.5	<b>11.100</b>
FPV/Z27D/INC	27	31.5	32	72.5	<b>15.500</b>
FPV/Z34D/INC	34	30	36	75	<b>21.900</b>
FPV/Z42D/INC	42	35.5	39.5	86	<b>26.800</b>
FPV/Z49D/INC	49	38.5	42.5	93.5	<b>45.000</b>
FPV/Z60D/INC	60	43	48	105	<b>65.100</b>

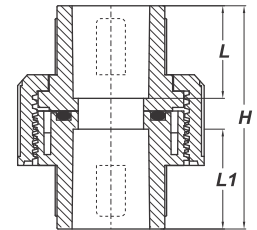
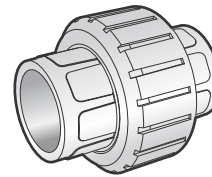
**Nối thu - Reducer**

Mã số Code	Kích cỡ Size	L	L1	H	Đơn giá Unit Price (VND/cái)
<b>Loại áp lực cao - Thick fittings</b>					
FPV/NT2721D/INC	27 x 21	30	35	71	<b>3.300</b>
FPV/NT3421D/INC	34 x 21	30	40	84	<b>4.100</b>
FPV/NT3427D/INC	34 x 27				<b>4.800</b>
FPV/NT4221D/INC	42 x 21	30	45	83	<b>5.900</b>
FPV/NT4227D/INC	42 x 27	35	44	86.5	<b>6.300</b>
FPV/NT4234D/INC	42 x 34	40	45	89	<b>7.000</b>
FPV/NT4921D/INC	49 x 21	30	55	103	<b>8.300</b>
FPV/NT4927D/INC	49 x 27	35	55	101	<b>8.800</b>
FPV/NT4934D/INC	49 x 34	40	55	102.5	<b>9.800</b>
FPV/NT4942D/INC	49 x 42	45	55	105	<b>10.500</b>
FPV/NT6021D/INC	60 x 21	30	63	114	<b>12.500</b>
FPV/NT6027D/INC	60 x 27	35	64	115	<b>13.200</b>
FPV/NT6034D/INC	60 x 34	40	64	117	<b>14.500</b>
FPV/NT6042D/INC	60 x 42	45	64	116.5	<b>15.200</b>
FPV/NT6049D/INC	60 x 49	55	64	131	<b>15.600</b>

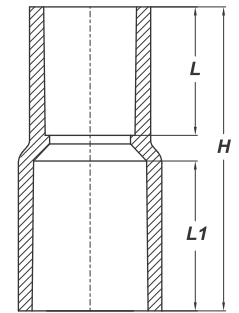

**Đầu bịt - End cap**

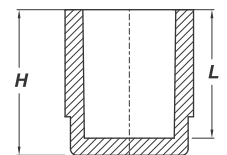
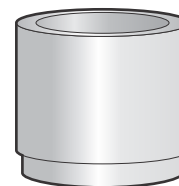
Mã số Code	Kích cỡ Size	L	H	Đơn giá Unit Price (VND/cái)
<b>Loại áp lực cao - Thick fittings</b>				
FPV/DB21D/INC	21	30	34	<b>2.000</b>
FPV/DB27D/INC	27	35	39	<b>2.200</b>
FPV/DB34D/INC	34	41	45	<b>4.100</b>
FPV/DB42D/INC	42	45	50	<b>5.300</b>
FPV/DB49D/INC	49	55	60.5	<b>8.000</b>
FPV/DB60D/INC	60	64	70	<b>13.500</b>

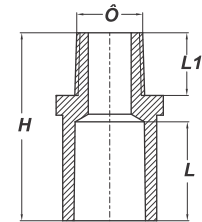
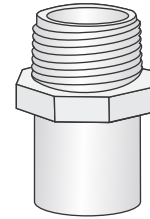

**Nối thẳng ren ngoài (nhựa) - Plastic male threaded socket**

Mã số Code	Kích cỡ Size	Ø	L1	L	H	Đơn giá Unit Price (VND/cái)
<b>Loại áp lực cao - Thick fittings</b>						
FPV/MT21x1/2D/INC	21	1/2"	19	30	57	<b>2.200</b>
FPV/MT27x3/4D/INC	27	3/4"	21	35	64	<b>3.300</b>
FPV/MT34x1D/INC	34	1"	23	40	72	<b>5.600</b>
FPV/MT42x1¼D/INC	42	1¼"	26	45	81	<b>8.100</b>
FPV/MT49x1½D/INC	49	1½"	27	55	93	<b>9.900</b>
FPV/MT60x2D/INC	60	2"	31	64	101	<b>14.600</b>

**Nối thẳng ren trong (nhựa) - Plastic female threaded socket**

Mã số Code	Kích cỡ Size	Ø	L1	L	H	Đơn giá Unit Price (VND/cái)
<b>Loại áp lực cao - Thick fittings</b>						
FPV/FT21x1/2D/INC	21	1/2"	16	30	48	<b>2.300</b>
FPV/FT27x3/4D/INC	27	3/4"	20	35	58.5	<b>3.600</b>
FPV/FT34x1D/INC	34	1"	21	40	64	<b>5.800</b>
FPV/FT42x1¼D/INC	42	1¼"	24	45	72	<b>7.900</b>
FPV/FT49x1½D/INC	49	1½"	28	55	86.5	<b>11.600</b>
FPV/FT60x2D/INC	60	2"	29	64	96	<b>18.000</b>

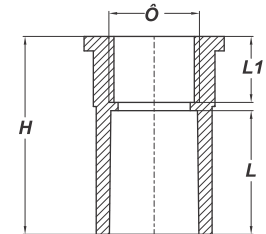
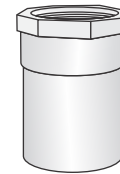
**Nối thu có ren ngoài - Male threaded reducing**

Mã số Code	Kích cỡ Size	Ø	L1	L	H	Đơn giá Unit Price (VND/cái)
<b>Loại áp lực cao - Thick fittings</b>						
FPV/MTR2127D/INC	21 x 27	3/4"	21	30	54.5	<b>2.500</b>
FPV/MTR2734D/INC	27 x 34	1"	22.5	35	62.5	<b>3.500</b>
FPV/MTR3427D/INC	34 x 27	3/4"	21	40	71.5	<b>4.600</b>

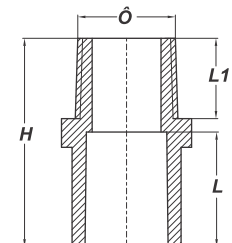
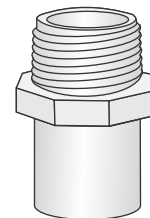

**Nối thu có ren trong - Female threaded reducing**

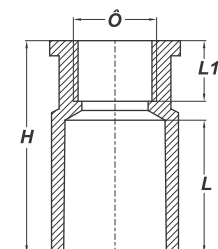
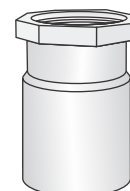
Mã số Code	Kích cỡ Size	Ø	L1	L	H	Đơn giá Unit Price (VND/cái)
<b>Loại áp lực cao - Thick fittings</b>						
FPV/FTR2721D/INC	27 x 21	1/2"	16	35	56	<b>3.100</b>
FPV/FTR3427D/INC	34 x 27	3/4"	20	40	62.5	<b>4.600</b>

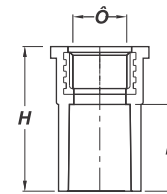
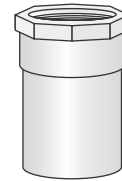

**Nối thẳng ren trong (ren đồng) - Adaptor Sockets (with brass thread)**

Mã số Code	Kích cỡ Size	Ø	L	H	Đơn giá Unit Price (VND/cái)
<b>Loại áp lực cao - Thick fittings</b>					
FPV/ASU21x1/2D/INC	21 x 1/2"	1/2"	30	46	<b>8.000</b>
FPV/ASU27x1/2D/INC	27 x 1/2"	1/2"	35	53.5	<b>8.800</b>
FPV/ASU27x3/4D/INC	27 x 3/4"	3/4"	40	55	<b>14.000</b>

**Nối thẳng ren ngoài (ren đồng) - Adaptor Bushes Equal (with brass thread)**

Mã số Code	Kích cỡ Size	Ø	L	L1	H	Đơn giá Unit Price (VND/cái)
<b>Loại áp lực cao - Thick fittings</b>						
FPV/AEU21x1/2D/INC	21 x 1/2"	1/2"	30	13	46	<b>21.000</b>
FPV/AEU27x1/2D/INC	27 x 1/2"	1/2"	35	13	53.5	<b>23.100</b>
FPV/AEU27x3/4D/INC	27 x 3/4"	3/4"	40	15	55	<b>23.100</b>

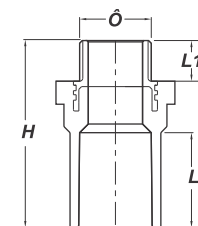
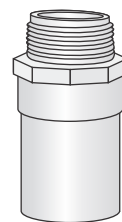
**Nối góc 90° ren trong (ren đồng) - Faucet Elbows 90° (with brass thread)**

Mã số Code	Kích cỡ Size	L	Z	H	Đơn giá Unit Price (VND/cái)
<b>Loại áp lực cao - Thick fittings</b>					
FPV/FEU21x1/2D/INC	21 x 1/2"	30	10	32	<b>13.800</b>
FPV/FEU27x1/2D/INC	27 x 1/2"	35	14	34	<b>17.600</b>
FPV/FEU27x3/4D/INC	27 x 3/4"	35	14	33	<b>17.700</b>
FPV/FEU34x1/2D/INC	34 x 1/2"	40	19.5	38	<b>19.000</b>
FPV/FEU34x3/4D/INC	34 x 3/4"	40	19.5	37	<b>22.000</b>

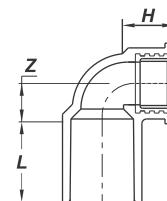
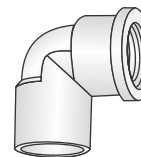

**Nối góc 90° ren ngoài (ren đồng) - Male Thread Elbows 90° (with brass thread)**

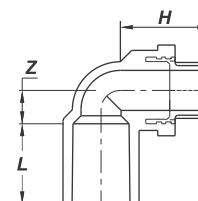
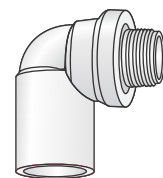
Mã số Code	Kích cỡ Size	L	Z	H	Đơn giá Unit Price (VND/cái)
<b>Loại áp lực cao - Thick fittings</b>					
FPV/MEU21x1/2D/INC	21 x 1/2"	30	10	45	<b>19.000</b>
FPV/MEU27x1/2D/INC	27 x 1/2"	35	14	47	<b>26.000</b>
FPV/MEU27x3/4D/INC	27 x 3/4"	35	14	48	<b>31.600</b>
FPV/MEU34x1/2D/INC	34 x 1/2"	40	19.5	50	<b>28.600</b>
FPV/MEU34x3/4D/INC	34 x 3/4"	40	19.5	52	<b>28.600</b>

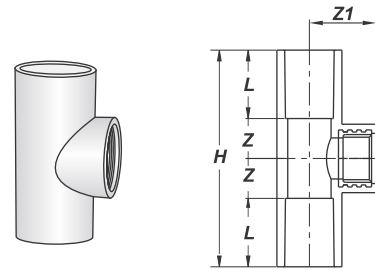

**Tê 90° ren trong (ren đồng) - Faucet Tees 90° (with brass thread)**

Mã số Code	Kích cỡ Size	L	Z	Z1	H	Đơn giá Unit Price (VND/cái)
<b>Loại áp lực cao - Thick fittings</b>						
<b>FPV/FTU21x1/2D/INC</b>	21 x 1/2"	30	10	32	80	<b>15.000</b>
<b>FPV/FTU27x1/2D/INC</b>	27 x 1/2"	35	10	35	90	<b>16.800</b>
<b>FPV/FTU27x3/4D/INC</b>	27 x 3/4"	35	14	35	98	<b>16.800</b>

**Tê 90° ren ngoài (ren đồng) - Male Thread Tees 90° (with brass thread)**

Mã số Code	Kích cỡ Size	L	Z	Z1	H	Đơn giá Unit Price (VND/cái)
<b>Loại áp lực cao - Thick fittings</b>						
<b>FPV/MTU21x1/2D/INC</b>	21 x 1/2"	30	10	32	80	<b>19.000</b>
<b>FPV/MTU27x1/2D/INC</b>	27 x 1/2"	35	10	35	90	<b>29.500</b>
<b>FPV/MTU27x3/4D/INC</b>	27 x 3/4"	35	14	35	98	<b>29.500</b>

