Ống u.PVC - CT Pipes

Mã số Code	Đường kính de	PN (Bar)	L	e	Đơn giá Unit Price (VND) (Ống trơn + Nong U)	Đơn giá Unit Price (VND) (Ống nong R)
PV/21CT/4	Ø21	4.0	32	1.00	6.800	-
PV/27CT/4	Ø27	4.0	32	1.00	8.500	-
PV/34CT/4	Ø34	4.0	34	1.00	11.000	-
PV/42CT/4	Ø42	4.0	42	1.20	16.600	-
PV/48CT/5	Ø48	5.0	48	1.40	19.300	-
PV/60CT/4	Ø60	4.0	60	1.40	25.200	27.200
PV/75CT/4	Ø75	4.0	70	1.50	35.300	38.100
PV/90CT/3	Ø90	3.0	79	1.50	43.100	46.500
PV/110CT/3	Ø110	3.0	91	1.90	65.200	70.500
PV/125CT/3	Ø125	3.0	100	2.00	71.900	77.800
PV/140CT/3	Ø140	3.0	109	2.20	88.600	95.800
PV/160CT/3	Ø160	3.0	121	2.50	115.000	124.200
PV/180CT/3	Ø180	3.0	133	2.80	144.500	156.100
PV/200CT/3	Ø200	3.0	145	3.20	215.800	233.100
PV/225CT/3	Ø225	3.0	160	3.50	224.000	241.900
PV/250CT/3	Ø250	3.0	175	3.90	291.600	314.900
PV/280CT/3	Ø280	3.0	193	4.40	435.900	470.800

Ống u.PVC - C0 Pipes

Mã số Code	Đường kính de	PN (Bar)	L	e	Đơn giá Unit Price (VND) (Ống trơn + Nong U)	Đơn giá Unit Price (VND) (Ống nong R)
PV/21C0/10	Ø21	10.0	32	1.25	8.500	9.200
PV/27C0/10	Ø27	10.0	32	1.30	10.800	11.800
PV/34C0/8	Ø34	8.0	34	1.30	13.000	14.000
PV/42C0/6	Ø42	6.0	42	1.50	18.500	20.000
PV/48C0/6	Ø48	6.0	48	1.65	22.600	24.500
PV/60C0/5	Ø60	5.0	60	1.65	30.200	32.600
PV/75C0/5	Ø75	5.0	70	1.90	41.200	44.500
PV/90C0/4	Ø90	4.0	79	1.90	49.300	53.200
PV/110C0/4	Ø110	4.0	91	2.25	73.800	79.800
PV/125C0/4	Ø125	4.0	100	2.50	90.600	97.800
PV/140C0/4	Ø140	4.0	109	2.80	112.800	121.800
PV/160C0/4	Ø160	4.0	121	3.20	150.600	162.600
PV/180C0/4	Ø180	4.0	133	3.60	185.500	200.300
PV/200C0/4	Ø200	4.0	145	3.90	226.300	244.500
PV/225C0/4	Ø225	4.0	160	4.40	277.300	299.500
PV/250C0/4	Ø250	4.0	175	4.90	363.500	392.600
PV/280C0/4	Ø280	4.0	193	5.50	435.800	470.600
PV/315C0/4	Ø315	4.0	214	6.2	551.000	595.100

Để đặt hàng ống trơn (ống không có đầu nong) thêm ký tự **T** vào sau ký tự **PV** trong phần mã số VD: **PVT/21CT/4**

Để đặt hàng ống nong R thêm ký tự **R** vào sau ký tự **PV** trong phần mã số VD: **PVR/21CT/4**

Mã trên là mã sản phẩm màu ghi. Muốn đặt sản phẩm màu trắng thêm **WH** vào cuối. VD: Mã **PV/21CT/4** sẽ thành **PV/21CT/4/WH**

Ống u.PVC - C1 Pipes

Mã số Code	Đường kính de	PN (Bar)	L	e	Đơn giá Unit Price (VND) (Ống trơn + Nong U)	Đơn giá Unit Price (VND) (Ống nong R)
PV/21C1/12.5	Ø21	12.5	32	1.5	9.200	9.900
PV/27C1/12.5	Ø27	12.5	32	1.6	12.600	13.600
PV/34C1/10	Ø34	10.0	34	1.7	16.000	17.300
PV/42C1/8	Ø42	8.0	42	1.8	21.800	23.500
PV/48C1/8	Ø48	8.0	48	2.0	26.000	28.100
PV/60C1/6	Ø60	6.0	60	2.0	36.800	39.800
PV/75C1/6	Ø75	6.0	70	2.2	46.800	50.500
PV/90C1/5	Ø90	5.0	79	2.2	57.800	62.500
PV/110C1/5	Ø110	5.0	91	2.7	85.900	92.800
PV/125C1/5	Ø125	5.0	100	3.1	106.200	114.600
PV/140C1/5	Ø140	5.0	109	3.5	132.800	143.500
PV/160C1/5	Ø160	5.0	121	4.0	175.500	189.500
PV/180C1/5	Ø180	5.0	133	4.4	215.100	232.300
PV/200C1/5	Ø200	5.0	145	4.9	273.300	295.200
PV/225C1/5	Ø225	5.0	160	5.5	333.300	360.000
PV/250C1/5	Ø250	5.0	175	6.2	438.300	473.300
PV/280C1/5	Ø280	5.0	193	6.9	521.300	563.000
PV/315C1/5	Ø315	5.0	214	7.7	654.200	706.500
PV/355C1/5	Ø355	5.0	238	8.7	854.600	923.000
PV/400C1/5	Ø400	5.0	265	9.8	1.086.000	1.173.000
PV/450C1/5	Ø450	5.0	295	11.0	1.373.000	1.483.000

Ống u.PVC - C2 Pipes

Mã số Code	Đường kính de	PN (Bar)	L	e	Đơn giá Unit Price (VND) (Ống trơn + Nong U)	Đơn giá Unit Price (VND) (Ống nong R)
PV/21C2/16	Ø21	16.0	32	1.80	11.000	11.900
PV/27C2/16	Ø27	16.0	32	2.00	14.000	15.100
PV/34C2/12.5	Ø34	12.5	34	2.00	19.300	20.800
PV/42C2/10	Ø42	10.0	42	2.10	24.800	26.800
PV/48C2/10	Ø48	10.0	48	2.40	29.900	32.300
PV/60C2/8	Ø60	8.0	60	2.40	42.800	46.200
PV/75C2/8	Ø75	8.0	70	2.90	60.800	65.600
PV/90C2/6	Ø90	6.0	79	2.90	66.600	71.900
PV/110C2/6	Ø110	6.0	91	3.20	97.800	105.600
PV/125C2/6	Ø125	6.0	100	3.70	125.800	135.900
PV/140C2/6	Ø140	6.0	109	4.10	156.500	169.000
PV/160C2/6	Ø160	6.0	121	4.70	202.600	218.800
PV/180C2/6	Ø180	6.0	133	5.30	256.000	276.500
PV/200C2/6	Ø200	6.0	145	5.90	318.800	344.300
PV/225C2/6	Ø225	6.0	160	6.60	395.000	426.600
PV/250C2/6	Ø250	6.0	175	7.30	511.500	552.500
PV/280C2/6	Ø280	6.0	193	8.20	614.000	663.100
PV/315C2/6	Ø315	6.0	214	9.20	784.800	847.600
PV/355C2/6	Ø355	6.0	238	10.40	1.016.000	1.097.000
PV/400C2/6	Ø400	6.0	265	11.70	1.292.000	1.395.000
PV/450C2/6	Ø450	6.0	295	13.20	1.638.000	1.769.000

Ống u.PVC - C3, C4 Pipes

Mã số Code		Đường kính de		PN (Bar)		L		e		Đơn giá Unit Price (VND) (Ống trơn + Nong U)		Đơn giá Unit Price (VND) (Ống nong R)	
C3	C4	C3	C4	C3	C4	C3	C4	C3	C4	C3	C4	C3	C4
PV/21C3/25	-	Ø21	-	25.0	-	32	-	2.40	-	13.000	-	14.000	-
PV/27C3/25	-	Ø27	-	25.0	-	32	-	3.00	-	19.900	-	21.500	-
PV/34C3/16	PV/34C4/25	Ø34	Ø34	16.0	25.0	34	34	2.60	3.60	22.200	32.800	24.000	35.500
PV/42C3/12.5	PV/42C4/16	Ø42	Ø42	12.5	16.0	42	42	2.60	3.00	29.200	36.000	31.500	38.900
PV/48C3/12.5	PV/48C4/16	Ø48	Ø48	12.5	16.0	48	48	3.00	3.70	36.200	45.500	39.100	49.100
PV/60C3/10	PV/60C4/12.5	Ø60	Ø60	10.0	12.5	60	60	3.00	3.80	51.800	64.900	55.900	70.100
PV/75C3/10	PV/75C4/12.5	Ø75	Ø75	10.0	12.5	70	70	3.60	4.50	75.500	95.000	81.500	102.600
PV/90C3/8	PV/90C4/10	Ø90	Ø90	8.0	10.0	79	79	3.60	4.30	87.500	108.500	94.500	117.200
PV/110C3/8	PV/110C4/10	Ø110	Ø110	8.0	10.0	91	91	4.20	5.30	137.000	163.900	148.000	177.000
PV/125C3/8	PV/125C4/10	Ø125	Ø125	8.0	10.0	100	100	4.80	6.00	159.600	201.000	172.300	217.100
PV/140C3/8	PV/140C4/10	Ø140	Ø140	8.0	10.0	109	109	5.40	6.70	209.300	247.100	226.000	266.900
PV/160C3/8	PV/160C4/10	Ø160	Ø160	8.0	10.0	121	121	6.20	7.70	262.000	332.600	283.000	359.200
PV/180C3/8	PV/180C4/10	Ø180	Ø180	8.0	10.0	133	133	6.90	8.60	327.000	418.500	353.200	452.000
PV/200C3/8	PV/200C4/10	Ø200	Ø200	8.0	10.0	145	145	7.70	9.60	405.800	519.800	438.300	561.400
PV/225C3/8	PV/225C4/10	Ø225	Ø225	8.0	10.0	160	160	8.60	10.80	513.000	658.000	554.000	710.600
PV/250C3/8	PV/250C4/10	Ø250	Ø250	8.0	10.0	175	175	9.60	11.90	661.100	835.800	714.000	902.600
PV/280C3/8	PV/280C4/10	Ø280	Ø280	8.0	10.0	193	193	10.70	13.40	789.000	1.082.000	852.100	1.168.000
PV/315C3/8	PV/315C4/10	Ø315	Ø315	8.0	10.0	214	214	12.10	15.00	986.000	1.365.000	1.065.000	1.474.000
PV/355C3/8	PV/355C4/10	Ø355	Ø355	8.0	10.0	238	238	13.60	16.90	1.319.000	1.622.000	1.425.000	1.752.000
PV/400C3/8	PV/400C4/10	Ø400	Ø400	8.0	10.0	265	265	15.30	19.10	1.672.000	2.065.000	1.806.000	2.230.000
PV/450C3/8	PV/450C4/10	Ø450	Ø450	8.0	10.0	295	295	17.20	21.50	2.115.000	2.620.000	2.285.000	2.830.000

Ống u.PVC - C5, C6 Pipes

Mã số Code		Đường kính de		PN (Bar)		L		e		Đơn giá Unit Price (VND) (Ống trơn + Nong U)		Đơn giá Unit Price (VND) (Ống nong R)	
C5	C6	C5	C6	C5	C6	C5	C6	C5	C6	C5	C6	C5	C6
PV/42C5/25	-	Ø42	-	25	-	42	-	4.50	-	48.500	-	52.500	-
PV/48C5/25	-	Ø48	-	25	-	48	-	5.60	-	65.200	-	70.500	-
PV/60C5/16	PV/60C6/25	Ø60	Ø60	16	25	60	60	4.70	7.10	78.000	114.600	84.200	123.800
PV/75C5/16	PV/75C6/25	Ø75	Ø75	16	25	70	70	5.50	8.40	114.600	165.500	123.800	179.000
PV/90C5/12.5	PV/90C6/16	Ø90	Ø90	12.5	16	79	79	5.40	6.60	134.900	163.000	145.800	176.000
PV/110C5/12.5	PV/110C6/16	Ø110	Ø110	12.5	16	91	91	6.60	8.10	202.300	245.300	218.500	264.900
PV/125C5/12.5	PV/125C6/16	Ø125	Ø125	12.5	16	100	100	7.40	9.20	246.400	302.300	266.100	326.500
PV/140C5/12.5	PV/140C6/16	Ø140	Ø140	12.5	16	109	109	8.30	10.3	315.000	386.600	340.200	417.500
PV/160C5/12.5	PV/160C6/16	Ø160	Ø160	12.5	16	121	121	9.50	11.8	408.200	502.000	440.900	542.200
PV/180C5/12.5	PV/180C6/16	Ø180	Ø180	12.5	16	133	133	10.7	13.3	518.500	636.000	560.000	686.900
PV/200C5/12.5	PV/200C6/16	Ø200	Ø200	12.5	16	145	145	11.9	14.7	640.800	782.500	692.100	845.100
PV/225C5/12.5	PV/225C6/16	Ø225	Ø225	12.5	16	160	160	13.4	16.6	813.200	972.800	878.300	1.050.600
PV/250C5/12.5	PV/250C6/16	Ø250	Ø250	12.5	16	175	175	14.8	18.4	1.035.000	1.262.000	1.118.000	1.363.000
PV/280C5/12.5	PV/280C6/16	Ø280	Ø280	12.5	16	193	193	16.6	20.6	1.242.000	1.514.000	1.340.000	1.635.000
PV/315C5/12.5	PV/315C6/16	Ø315	Ø315	12.5	16	214	214	18.7	23.2	1.573.000	1.915.000	1.699.000	2.068.000
PV/355C5/12.5	PV/355C6/16	Ø355	Ø355	12.5	16	238	238	21.1	26.1	2.002.000	2.439.000	2.162.000	2.634.000
PV/400C5/12.5	PV/400C6/16	Ø400	Ø400	12.5	16	265	265	23.7	29.4	2.532.000	3.188.000	2.735.000	3.443.000
PV/450C5/12.5	PV/450C6/16	Ø450	Ø450	12.5	16	295	295	26.7	33.1	3.468.000	4.180.000	3.780.000	4.560.000

Để đặt hàng ống trơn (ống không có đầu nong) thêm ký tự **T** vào sau ký tự **PV** trong phần mã số VD: **PVT/21CT/4**

Để đặt hàng ống nong R thêm ký tự **R** vào sau ký tự **PV** trong phần mã số VD: **PVR/21CT/4**

Mã trên là mã sản phẩm màu ghi. Muốn đặt sản phẩm màu trắng thêm **WH** vào cuối. VD: Mã **PV/21CT/4** sẽ thành **PV/21CT/4/WH**

Ống lọc nước - u-PVC Filter Pipes

Mã số Code	Kích cỡ Size	Đơn giá Unit Price (VND/m)
PVL/48C0	Ø 48	38.000
PVL/48C1	Ø 48	46.800
PVL/90C2	Ø 90	106.000

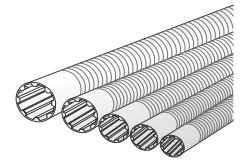
Ống thoát nước siêu tốc và giảm âm u.PVC 1 vách - Single wall spiral silencing PVC.u pipe

Mã số Code	Kích cỡ Size	e	PN (Bar)	Đơn giá Unit Price (VND/m)
PVS/75/8	Ø 75	2.9	8	50.200
PVS/90/6	Ø 90	2.9	6	56.800
PVS/110/6	Ø 110	3.2	6	81.200
PVS/140/5	Ø 140	3.5	5	110.000
PVS/160/5	Ø 160	3.8	5	147.000

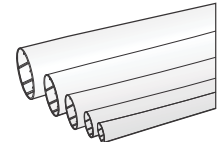

Ống thoát nước điều hoà và tưới tiêu nước - Flexible Conduit for Air Conditioner and Irrigation

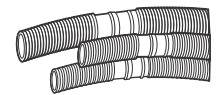
Mã số Code	Kích cỡ Size	Đơn giá Unit Price (VND/m)	Đơn giá Unit Price (VND/cuộn)
SP 9020DH	20	5.340	267.000
SP 9025DH	25	7.800	312.000

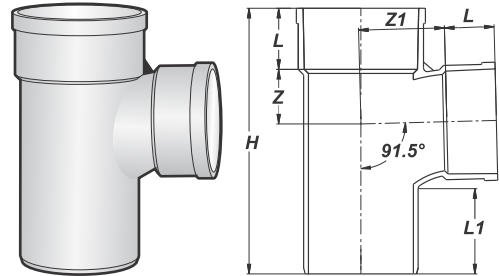

PHỤ KIỆN u-PVC THEO TIÊU CHUẨN CHÂU ÂU EN 1401-1 : 1998
Tê 90° (91.5°) một đầu nối trong - Tee 90° (91.5°) with single socket

Mã số Code	Kích cỡ Size	PN (Bar)	L	Z	Z1	L1	H	Đơn giá Unit Price (VND/cái)
FPV/TT42NT/10	42	10	35	23.7	34	43	127	16.900
FPV/TT48NT/10	48	10	40.5	25	39	49	143	18.000
FPV/TT60NT/10	60	10	47.5	32	47.5	60	177.5	18.300
FPV/TT75NT/10	75	10	53	42.5	56	70	211	44.800
FPV/TT90NT/10	90	10	58	50.5	70	79	244.5	70.900
FPV/TT110NT/10	110	10	60.5	58.5	85.5	91.5	281	96.900
FPV/TT125NT/10	125	10	68.5	64.5	101	100.3	313.5	152.900
FPV/TT140NT/10	140	10	76	73	113	104.4	348.5	216.000
FPV/TT160NT/10	160	10	86	82	122.5	121.3	392	319.300
FPV/TT200NT/10	200	10	106	106	152.5	145.2	486	728.800

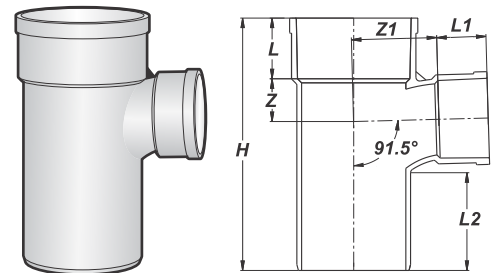

Tê thu 90° (91.5°) một đầu nối trong - Reducing Tee 90° (91.5°) with single socket

Mã số Code	Kích cỡ Size	PN (Bar)	L	Z	L1	Z1	L2	H	Đơn giá Unit Price (VND/cái)
FPV/TT6034NT/10	60 x 34	10	47.5	19.5	31	42	60	148.5	17.800
FPV/TT6042NT/10	60 x 42	10	47.5	23.5	35	43	60	157.5	17.800
FPV/TT6048NT/10	60 x 48	10	47.5	26.5	40.5	44.5	60	163.5	17.800
FPV/TT7534NT/10	75 x 34	10	53	20.5	31	51	70	165.5	31.500
FPV/TT7542NT/10	75 x 42	10	53	25	35	51	70	174.5	31.500
FPV/TT7548NT/10	75 x 48	10	53	28.5	40.5	53	70	181.5	31.500
FPV/TT7560NT/10	75 x 60	10	53	34.5	47.5	55	70	195	31.500
FPV/TT9042NT/10	90 x 42	10	58	26	35	59	79	189.5	57.000
FPV/TT9048NT/10	90 x 48	10	58	29	40.5	61.5	79	196.5	57.000
FPV/TT9060NT/10	90 x 60	10	58	35	47.5	62.5	79	209.5	57.000
FPV/TT9075NT/10	90 x 75	10	58	42.5	53	65	79	225.5	57.000
FPV/TT11048NT/10	110 x 48	10	60.5	28.5	40.5	72.5	91	210	96.900
FPV/TT11060NT/10	110 x 60	10	60.5	34.5	47.5	73.5	91	223.5	96.900
FPV/TT11075NT/10	110 x 75	10	60.5	42	53	76	91	239.5	96.900
FPV/TT11090NT/10	110 x 90	10	60.5	48.5	58	81	91	258	96.900
FPV/TT12560NT/10	125 x 60	10	68.5	35.5	47.5	82	100	242	148.000
FPV/TT12575NT/10	125 x 75	10	68.5	43.5	53	84.5	100	258.5	147.500
FPV/TT12590NT/10	125 x 90	10	68.5	50.5	58	89.5	100	277.5	147.500
FPV/TT125110NT/10	125 x 110	10	68.5	59.5	60.5	94	100	299.5	147.500
FPV/TT14060NT/10	140 x 60	10	76	30	47.5	92	109	255	190.000
FPV/TT14075NT/10	140 x 75	10	76	43	53	92.5	109	276	198.000
FPV/TT14090NT/10	140 x 90	10	76	49.5	58	97.5	109	293.5	198.000
FPV/TT140110NT/10	140 x 110	10	76	58.5	60.5	102.5	109	316.5	198.000
FPV/TT140125NT/10	140 x 125	10	76	64.5	76	109.5	109	331	198.000
FPV/TT16075NT/10	160 x 75	10	86	42	53	105	120	299	238.000
FPV/TT16090NT/10	160 x 90	10	86	49	58	109.5	121	316.5	269.500
FPV/TT160110NT/10	160 x 110	10	86	58.5	60.5	114	121	339.5	269.500
FPV/TT160125NT/10	160 x 125	10	86	64.5	68.5	121	121	354	269.500
FPV/TT160140NT/10	160 x 140	10	86	71	76	125.5	121	370	269.500
FPV/TT20090NT/10	200 x 90	10	106	53	58	131.5	145	365.5	637.100
FPV/TT200110NT/10	200 x 110	10	106	63	60.5	136	145	390	637.100
FPV/TT200125NT/10	200 x 125	10	106	69.5	68.5	143	145	404	637.100
FPV/TT200140NT/10	200 x 140	10	106	76.5	76	147.5	145	421	691.200
FPV/TT200160NT/10	200 x 160	10	106	87	90	144.5	145	442.5	691.200

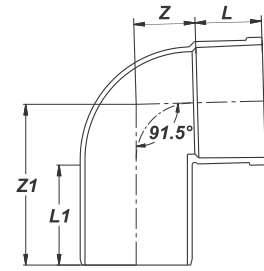
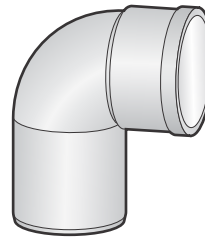

 Mã trên là mã sản phẩm màu ghi. Muốn đặt sản phẩm màu trắng thêm **WH** vào cuối. VD: Mã **FPV/T75/8** sẽ thành **FPV/T75/8/WH**

Nối góc 91.5° một đầu nối trong - Elbow 91.5° with single socket

Mã số Code	Kích cỡ Size	PN (Bar)	L	Z	L1	Z1	Đơn giá Unit Price (VND/cái)
FPV/G42NT/10	42	10	35	23	42	64.3	5.600
FPV/G48NT/10	48	10	40.5	26.5	48	73.7	9.000
FPV/G60NT/10	60	10	47.5	33	60	91.9	18.100
FPV/G75NT/10	75	10	53	41.2	70	110.1	42.300
FPV/G90NT/10	90	10	58	49.7	79	123.8	49.600
FPV/G110NT/10	110	10	60.5	60.8	91	149.8	76.800
FPV/G125NT/10	125	10	68.5	69.1	100	166.8	142.000
FPV/G140NT/10	140	10	76	77.4	109	183.7	259.800
FPV/G160NT/10	160	10	86	88.6	121	206.5	303.500

Nối góc 45° một đầu nối trong - Elbow 45° with single socket

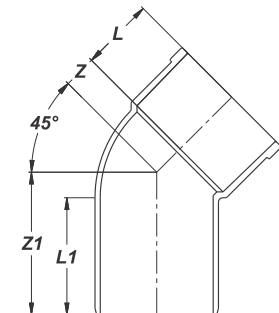
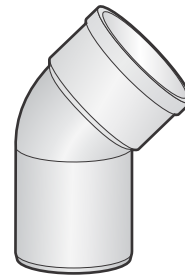
Mã số Code	Kích cỡ Size	PN (Bar)	L	Z	L1	Z1	Đơn giá Unit Price (VND/cái)
FPV/CH42NT/10	42	10	35	11.3	42	50.7	4.300
FPV/CH48NT/10	48	10	40.5	13	48	58	6.800
FPV/CH60NT/10	60	10	47.5	16.2	60	72.4	15.800
FPV/CH75NT/10	75	10	53	20.4	70	85.6	25.800
FPV/CH90NT/10	90	10	58	24.4	79	97.7	35.100
FPV/CH110NT/10	110	10	60.5	30.0	91	113.8	66.200
FPV/CH125NT/10	125	10	68.5	34.0	100	126.0	92.200
FPV/CH140NT/10	140	10	76	38.1	109	138.1	113.500
FPV/CH160NT/10	160	10	86	43.7	121	154.2	170.000
FPV/CH200NT/10	200	10	106	55	145	191.5	313.000
FPV/CH225NT/10	225	10	118.5	61.5	160	212.7	484.200
FPV/CH250NT/10	250	10	131	56.8	175	223.9	694.500
FPV/CH280NT/8	280	8	146	76.5	193	259	2.102.200
FPV/CH315NT/8	315	8	163.5	86	214	289.4	2.509.900

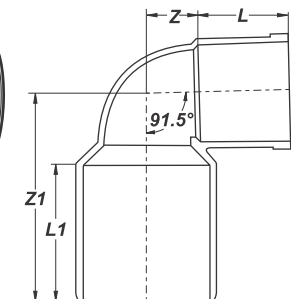
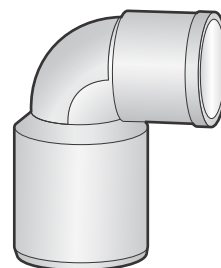

Nối thu 90° (91.5°) một đầu nối trong - Reducer Elbow 90° (91.5°) with single socket

Mã số Code	Kích cỡ Size	PN (Bar)	L	Z	L1	Z1	Đơn giá Unit Price (VND/cái)
FPV/GT3442NT/10	34 x 42	10	31	18	42	63	11.000
FPV/GT3448NT/10	34 x 48	10	31	18	48	72	16.800
FPV/GT3460NT/10	34 x 60	10	31	18	60	89	33.400
FPV/GT3475NT/10	34 x 75	10	31	18	70	106	43.100
FPV/GT4248NT/10	42 x 48	10	35	23	48	71.4	16.800
FPV/GT4260NT/10	42 x 60	10	35	23	60	89	33.400
FPV/GT4275NT/10	42 x 75	10	35	23	70	106	43.100
FPV/GT4290NT/10	42 x 90	10	35	23	79	121	59.600
FPV/GT4860NT/10	48 x 60	10	40.5	25.5	60	90	33.500
FPV/GT4875NT/10	48 x 75	10	40.5	25.5	70	106	42.900
FPV/GT4890NT/10	48 x 90	10	40.5	25.5	79	122	59.600
FPV/GT48110NT/10	48 x 110	10	40.5	25.5	91	142	93.300
FPV/GT6075NT/10	60 x 75	10	47.5	32.5	70	106	43.100
FPV/GT6090NT/10	60 x 90	10	47.5	32.5	79	122	59.600
FPV/GT60110NT/10	60 x 110	10	47.5	30.5	91	144	93.300
FPV/GT60125NT/10	60 x 125	10	47.5	32.5	100	158	123.100
FPV/GT7590NT/10	75 x 90	10	53	40	79	121	59.600
FPV/GT75110NT/10	75 x 110	10	53	40	91	142	93.300
FPV/GT75125NT/10	75 x 125	10	53	40	100	158	123.100
FPV/GT90110NT/10	90 x 110	10	58	49	91	143	93.300
FPV/GT90125NT/10	90 x 125	10	58	49	100	159	123.100
FPV/GT110125NT/10	110 x 125	10	60.5	51.5	100	159	123.100

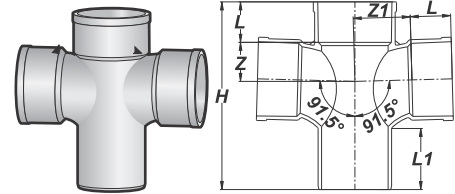

Thập đều 91.5° một đầu nối trong - Equal Cross 91.5° with single socket

Mã số Code	Kích cỡ Size	PN (Bar)	L	Z	Z1	L1	H	Đơn giá Unit Price (VND/cái)
FPV/TH110NT/12.5	110	12.5	73	58.5	87	91	296	358.000
FPV/TH125NT/12.5	125	12.5	76	64.5	102	100	324	469.800
FPV/TH140NT/12.5	140	12.5	80	73	115	109	355	582.000
FPV/TH160NT/12.5	160	12.5	90	82	123	121	398	699.500

Thập thu 91.5° một đầu nối trong - Reducing Cross 91.5° with single socket

Mã số Code	Kích cỡ Size	PN (Bar)	L	Z	L1	Z1	L2	H	Đơn giá Unit Price (VND/cái)
FPV/THT12590NT/12.5	125 x 90	12.5	76	50.5	58	89.5	100	284	380.000
FPV/THT140110NT/12.5	140 x 110	12.5	80	59.5	73	104	109.4	321.5	410.000
FPV/THT160110NT/12.5	160 x 110	12.5	90	58.5	73	114	121	345	629.000
FPV/THT200160NT/12.5	200 x 160	12.5	115	87	90	140.5	145	455	643.500

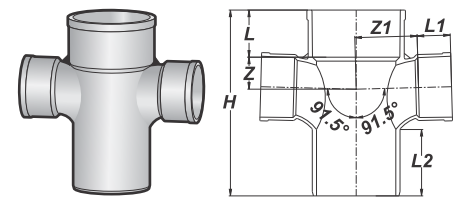
Thập đều 91.5° khác hướng một đầu nối trong - Equal Cross 91.5° with single socket

Mã số Code	Kích cỡ Size	PN (Bar)	L	Z	Z1	L1	H	Đơn giá Unit Price (VND/cái)
FPV/THK110NT/12.5	110	12.5	73	58.5	87	91	296	410.000

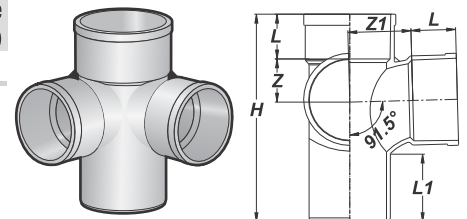
Thập thu 91.5° khác hướng một đầu nối trong - Reducing Cross 91.5° with single socket

Mã số Code	Kích cỡ Size	PN (Bar)	L	Z	L1	Z1	L2	H	Đơn giá Unit Price (VND/cái)
FPV/TKT12590NT/12.5	125 x 90	12.5	76	50.5	58	89.5	100	284	420.000
FPV/TKT140110NT/12.5	140 x 110	12.5	80	59.5	73	104	109.4	321.5	450.000
FPV/TKT160110NT/12.5	160 x 110	12.5	90	58.5	73	114	121	345	630.000

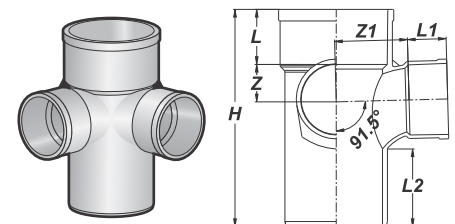
Tứ chạc 45° chuyển bậc một đầu nối trong - Four fork 45° step shift with single socket

Mã số Code	Kích cỡ Size	PN (Bar)	L	Z	L1	Z1	H	Đơn giá Unit Price (VND/cái)
FPV/TCT12590NT/10	125 x 90	10	68.5	135	56	143	307	250.000
FPV/TCT14090NT/10	140 x 90	10	76	135.3	56	153	316	320.000
FPV/TCT140110NT/10	140 x 110	10	76	160	61	165	352	380.000
FPV/TCT160110NT/10	160 x 110	10	86	172	61	181	377	560.000

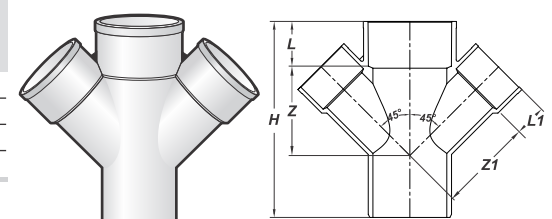

Mã trên là mã sản phẩm màu ghi. Muốn đặt sản phẩm màu trắng thêm **WH** vào cuối. VD: Mã **FPV/T75/8** sẽ thành **FPV/T75/8/WH**

Y 45° loại phổ thông nối trong - Normal Y Pieces 45°

Mã số Code	Kích cỡ Size	PN (Bar)	L	Z	H	Đơn giá Unit Price (VND/cái)
FPV/Y34/PT/12.5	34	12.5	30	44	112	6.500
FPV/Y42/PT/10	42	10	34	52	128	8.500
FPV/Y48/PT/10	48	10	35	61.8	142.7	16.000
FPV/Y60/PT/10	60	10	42	75.6	175	28.800
FPV/Y75/PT/10	75	10	55	97	230	46.900
FPV/Y90/PT/10	90	10	56.8	116	260	63.300
FPV/Y110/PT/10	110	10	61	138	301.5	96.300
FPV/Y125/PT/10	125	10	69	157	354.5	193.800
FPV/Y140/PT/10	140	10	76	177	391	308.300
FPV/Y160/PT/10	160	10	86	199	440	348.500
FPV/Y200/PT/10	200	10	106	250	543	702.200
FPV/Y225/PT/10	225	10	118.5	284.7	630	1.037.000
FPV/Y250/PT/10	250	10	131	315	675	1.320.000
FPV/Y280/PT/8	280	8	146	354	759	2.410.000
FPV/Y315/PT/8	315	8	163.5	394	845.5	2.587.000

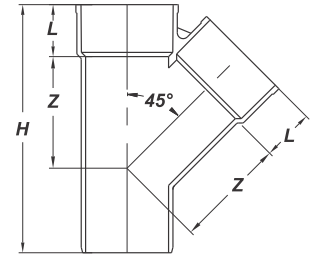
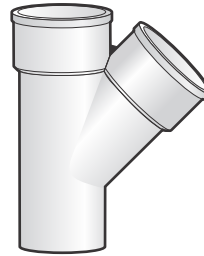
Y thu 45° loại phổ thông nối trong - Normal Reducing Y Pieces 45°

Mã số Code	Kích cỡ Size	PN (Bar)	L	Z	L1	Z1	H	Đơn giá Unit Price (VND/cái)
FPV/YT9060/PT/10	90 x 60	10	58	89	41	98	212	39.800
FPV/YT9075/PT/10	90 x 75	10	58	100	51	106	233.9	49.600
FPV/YT11060/PT/10	110 x 60	10	61	100	41	113	226	54.100
FPV/YT11090/PT/10	110 x 90	10	61	122	58	129	269.7	72.800
FPV/YT12548/PT/10	125 x 48	10	66	100	34	118	217.5	74.100
FPV/YT12560/PT/10	125 x 60	10	66	108	41	124	234	77.800
FPV/YT12575/PT/10	125 x 75	10	66	118	51	132	255	98.000
FPV/YT12590/PT/10	125 x 90	10	66	128	58	139	275.5	106.600
FPV/YT14090/PT/10	140 x 90	10	72	136	58	151	292	155.900
FPV/YT140110/PT/10	140 x 110	10	76	160	61	165	352	161.000
FPV/YT140125/PT/10	140 x 125	10	76	170	68.5	172	373	188.600
FPV/YT16090/PT/10	160 x 90	10	77	148	58	166	304.7	173.000
FPV/YT160110/PT/10	160 x 110	10	86	172	61	175	377	295.000
FPV/YT160125/PT/10	160 x 125	10	86	184	68.5	185	399	335.300
FPV/YT200160/PT/10	200 x 160	10	82	223.5	77	235	502.3	513.900
FPV/YT250160/PT/10	250 x 160	10	100	248	77	265.9	540	850.300
FPV/YT250200/PT/10	250 x 200	10	100	276.1	82	295	599	910.000

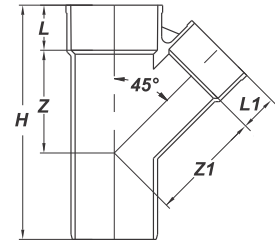
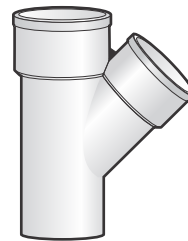

Nối thẳng một đầu nối trong - Coupling

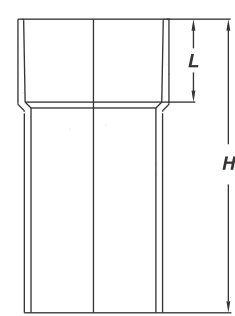
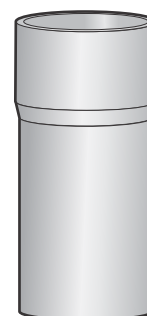
Mã số Code	Kích cỡ Size	PN (Bar)	L	H	Đơn giá Unit Price (VND/cái)
FPV/NT42/10	42	10	40	-	5.600
FPV/NT48/10	48	10	44	-	7.800
FPV/NT60/10	60	10	54	-	13.000
FPV/NT75/10	75	10	60	-	18.000
FPV/NT90/10	90	10	66	-	23.900
FPV/NT110/10	110	10	67	-	30.200
FPV/NT125/10	125	10	78	-	46.300
FPV/NT140/10	140	10	86	-	58.100
FPV/NT160/10	160	10	-	-	83.600
FPV/NT200/10	200	10	-	-	151.900

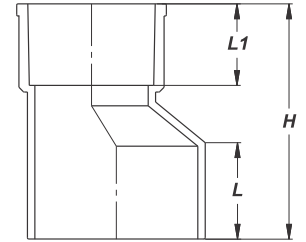
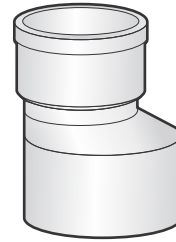

Nối thu lệch tâm dạng một đầu trong một đầu ngoài - Reducing Bushes

Mã số Code	Kích cỡ Size	PN (Bar)	L1	L	H	Đơn giá Unit Price (VND/cái)
FPV/NTN4234/10	42 x 34	10	29	25	66	3.100
FPV/NTN4834/10	48 x 34	10	29	26	70.5	3.500
FPV/NTN4842/10	48 x 42	10	31	26	68	3.500
FPV/NTN6034/10	60 x 34	10	29	31	82	5.600
FPV/NTN6042/10	60 x 42	10	31	31	80.5	5.600
FPV/NTN6048/10	60 x 48	10	34	31	80.5	5.600
FPV/NTN7534/10	75 x 34	10	29	40	100	7.600
FPV/NTN7542/10	75 x 42	10	31	40	98	8.100
FPV/NTN7548/10	75 x 48	10	34	40	96.5	8.200
FPV/NTN7560/10	75 x 60	10	41	40	98	9.300
FPV/NTN9034/10	90 x 34	10	29	46	114	11.500
FPV/NTN9042/10	90 x 42	10	31	46	112	11.900
FPV/NTN9048/10	90 x 48	10	34	46	111	12.500
FPV/NTN9060/10	90 x 60	10	41	46	112	12.800
FPV/NTN9075/10	90 x 75	10	51	46	114	13.500
FPV/NTN11034/10	110 x 34	10	29	48	128	15.600
FPV/NTN11042/10	110 x 42	10	31	48	126	15.600
FPV/NTN11048/10	110 x 48	10	34	48	125.5	16.900
FPV/NTN11060/10	110 x 60	10	41	48	126	18.500
FPV/NTN11075/10	110 x 75	10	57	48	127	20.500
FPV/NTN11090/10	110 x 90	10	58	48	126	20.500
FPV/NTN14090/10	140 x 90	10	58	56	151.5	24.200
FPV/NTN140110/10	140 x 110	10	61	56	143	24.600
FPV/NTN140125/10	140 x 125	10	66	56	149	86.100
FPV/NTN160110/10	160 x 110	10	61	60	158.5	90.500
FPV/NTN160125/10	160 x 125	10	66	60	157	90.500
FPV/NTN160140/10	160 x 140	10	72	60	152.2	93.600



Mã trên là mã sản phẩm màu ghi. Muốn đặt sản phẩm màu trắng thêm **WH** vào cuối. VD: Mã **FPV/T75/8** sẽ thành **FPV/T75/8/WH**

Khi thi công hệ thống phụ kiện theo tiêu chuẩn Châu Âu với nguyên lý đầu nối xuôi theo dòng nước, chúng ta cần tạo các đầu nóng ống. Để đảm bảo kinh tế kỹ thuật cho việc này, công ty đã chế tạo ra máy nong ống phục vụ tại hiện trường.

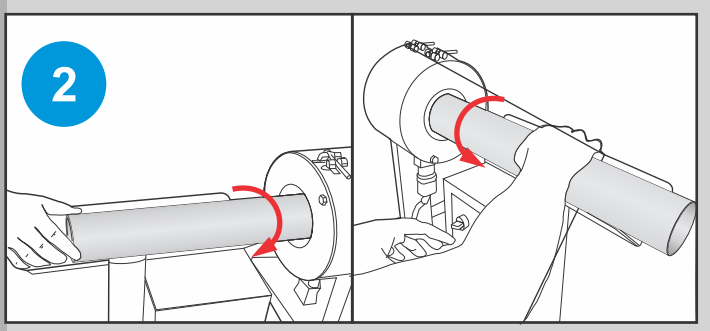
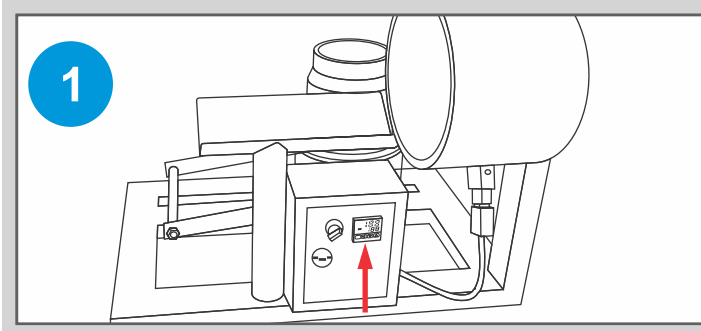

- Gia nhiệt cho lò theo nhiệt độ cài đặt cho từng loại ống (Bảng thông số gia nhiệt có trên hướng dẫn sử dụng máy)
- Làm sạch bề mặt trong, ngoài đoạn ống có đầu cần nong

- Khi đủ nhiệt độ, đút ống vào lò gia nhiệt (đút ngập phần đầu cần nong)
- Xoay đều để ống được gia nhiệt đều xung quanh

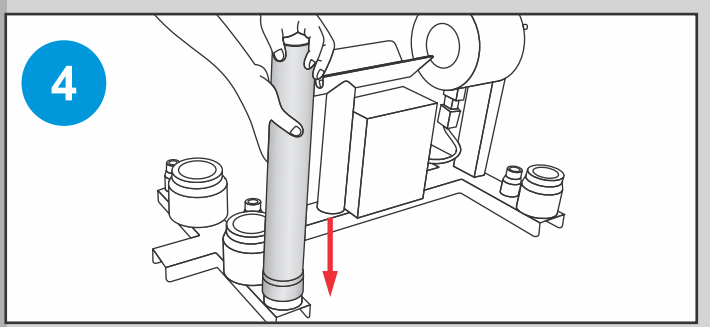
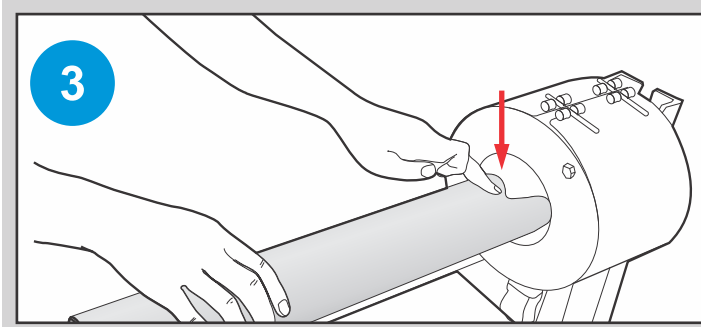

- Gia nhiệt khoảng tùy theo từng loại ống
- Dùng tay ấn để kiểm tra độ mềm

- Khi đạt mềm, cắm ống vào đầu nong

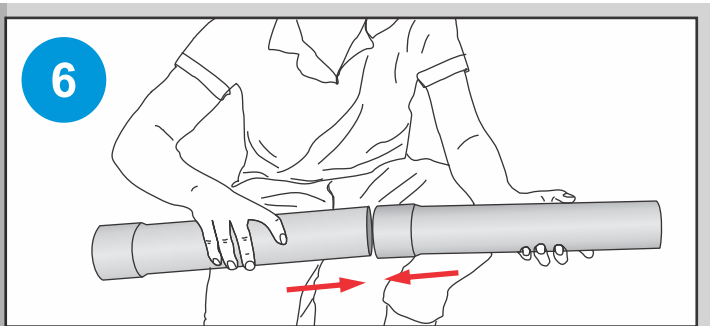
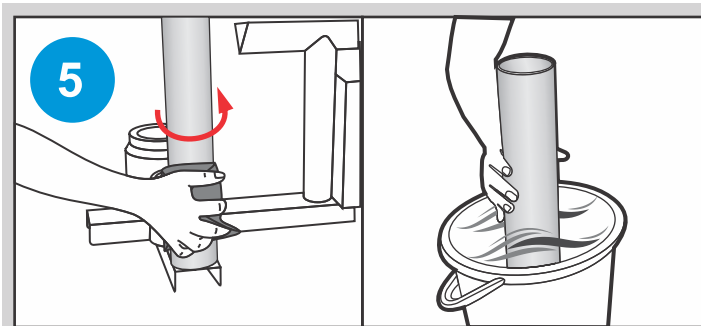

- Dùng khăn ướt để làm mát đầu nong, vừa làm mát vừa xoay ống
- Rút ống khỏi đầu nong và ngâm vào nước.

- Sau khi ngâm nước ta thử lắp ghép với ống cùng cỡ, vừa êm kín chắc là đạt

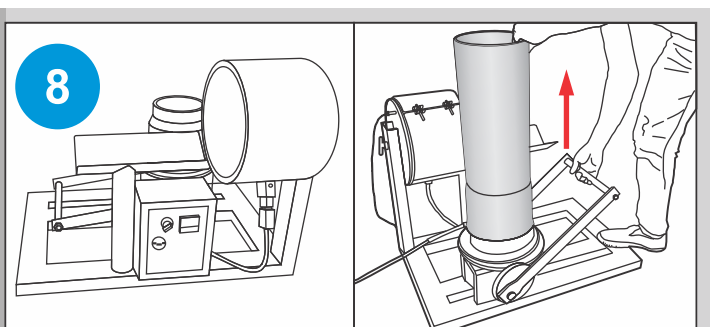
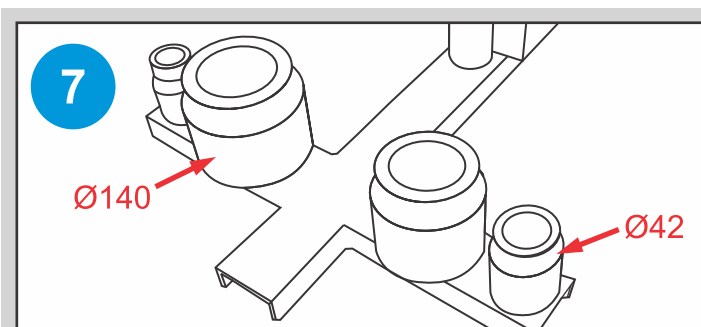

- Với lò gia nhiệt nhỏ ta nong được ống từ Ø42 - Ø140

- Với lò gia nhiệt to ta nong được ống từ Ø160 - Ø225
- Với lò gia nhiệt to ta sử dụng bộ đẩy ống ra khỏi khuôn nong

PHỤ KIỆN U-PVC 91.5°
Nối góc 91.5° cong - Elbow 91.5°

Mã số Code	Kích cỡ Size	PN (Bar)	L	Z	Kiểu dáng Shape	Đơn giá Unit Price (VND/cái)
FPV/G34/10	34	10	29	23	G	3.500
FPV/G42/10	42	10	31	27	G	5.600
FPV/G48/10	48	10	34	32	G	9.000
FPV/G60/10	60	10	41	40	G	18.100
FPV/G75/10	75	10	51	45	G	42.300
FPV/G90/10	90	10	58	52	G	49.600
FPV/G110/10	110	10	61	65	G	76.800
FPV/G140/10	140	10	72	80	G	151.200
FPV/G160/10	160	10	77	90	G	184.800
FPV/G200/10	200	10	82	116	G	415.800
FPV/G250/8	250	8	86	145	G	708.800
FPV/G250/10	250	10	115	145	G	785.200

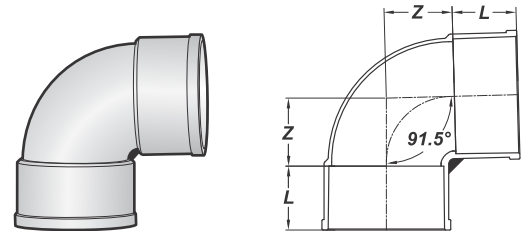

Kiểu G

Nối góc 91.5° cong có cửa kiểm tra - 91.5° Elbow with Inspection Hole

Mã số Code	Kích cỡ Size	PN (Bar)	L	Z	M	Kiểu dáng Shape	Đơn giá Unit Price (VND/cái)
FPV/GC42/10	42	10	31	27	M30 x 2	G	7.300
FPV/GC48/10	48	10	32	32	M30 x 2	G	8.500
FPV/GC75/10	75	10	51	45	M60 x 2	G	27.100
FPV/GC90/10	90	10	58	52	M60 x 2	G	42.300
FPV/GC110/10	110	10	61	65	M90 x 2.5	G	68.500
FPV/GC140/10	140	10	72	80	M90 x 2.5	G	155.500
FPV/GC160/10	160	10	77	90	M90 x 2.5	G	167.900

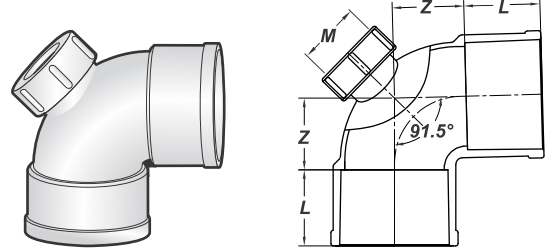

Kiểu G

Nối góc 45° - Elbow 45°

Mã số Code	Kích cỡ Size	PN (Bar)	L	Z	Kiểu dáng Shape	Đơn giá Unit Price (VND/cái)
FPV/CH42/10	42	10	31	11	G	10.500
FPV/CH48/10	48	10	34	11.5	G	6.800
FPV/CH60/10	60	10	41	14	G	15.800
FPV/CH75/10	75	10	51	17.5	G	25.800
FPV/CH75/12.5	75	12.5	66	20	G	29.800
FPV/CH90/10	90	10	58	22	G	35.300
FPV/CH90/12.5	90	12.5	70	24	G	37.900
FPV/CH110/10	110	10	61	25	G	66.200
FPV/CH110/12.5	110	12.5	73	9	G	70.900
FPV/CH125/12.5	125	12.5	76	32	G	92.200
FPV/CH140/8	140	8	72	32	G	85.000
FPV/CH140/12.5	140	12.5	80	36	G	113.500
FPV/CH160/8	160	8	77	36	G	129.900
FPV/CH160/12.5	160	12.5	90	41	G	170.000
FPV/CH200/10	200	10	99	47	G	313.000
FPV/CH225/10	225	10	118.5	61.5	G	484.200
FPV/CH250/8	250	8	128	60	G	502.000
FPV/CH250/10	250	10	131	68	G	694.500

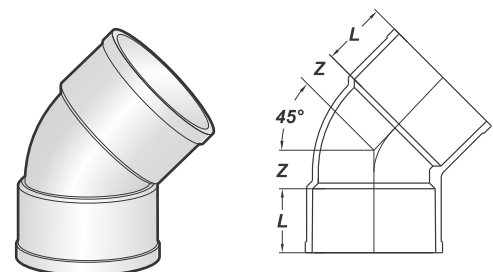

Kiểu G

Nối thẳng có cửa kiểm tra - Inspection Coupling

Mã số Code	Kích cỡ Size	PN (Bar)	L	Z	M	H	Kiểu dáng Shape	Đơn giá Unit Price (VND/cái)
FPV/NC48/10	48	10	34	24	M30 x 2	116	G	7.300
FPV/NC60/10	60	10	41	24	M30 x 2	130	G	14.800
FPV/NC75/10	75	10	51	35	M60 x 2	172	G	18.600
FPV/NC90/10	90	10	58	36	M60 x 2	188	G	28.100
FPV/NC110/10	110	10	61	52	M90 x 2.5	226	G	43.100
FPV/NC140/10	140	10	72	52	M90 x 2.5	248	G	75.300
FPV/NC160/10	160	10	77	53.5	M90 x 2.5	261	G	100.900

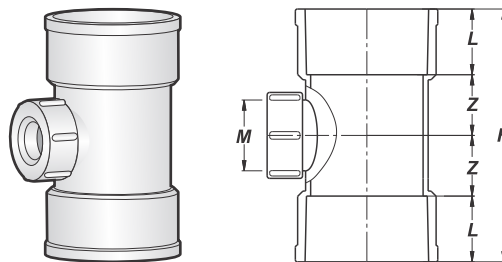

Kiểu G

Đốt co giãn - Flexible Coupling

Mã số Code	Kích cỡ Size	PN (Bar)	L	Z	H	Kiểu dáng Shape	Đơn giá Unit Price (VND/cái)
FPV/NG48/12.5	48	12.5	26	2.0	67	T	6.500
FPV/NG60/10	60	10	32	2.0	78	T	8.400
FPV/NG75/10	75	10	40	3.0	98	T	10.200
FPV/NG90/10	90	10	46	3.0	110	T	20.200
FPV/NG110/10	110	10	48	3.5	117	T	32.000
FPV/NG140/10	140	10	56	3.5	133	T	56.200
FPV/NG160/10	160	10	60	3.5	141	T	74.600
FPV/NG200/10	200	10	65	3.5	160	T	97.200
FPV/NG250/10	250	10	70	4.0	173	T	126.800

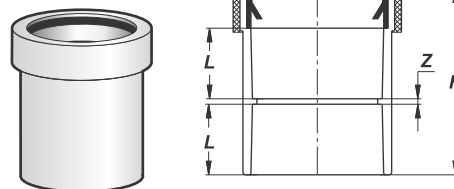

Kiểu T

Y đều 45° - Equal Pieces 45°

Mã số Code	Kích cỡ Size	PN (Bar)	L	Z	Z2	H	Kiểu dáng Shape	Đơn giá Unit Price (VND/cái)
FPV/Y34/10	34	10	29	43	8	109	G	5.900
FPV/Y42/10	42	10	31	53	9	124	G	8.400
FPV/Y48/10	48	10	34	63.5	10	142	G	16.000
FPV/Y60/8	60	8	40	80	19	179	T	21.600
FPV/Y60/10	60	10	41	75	14	170	G	28.800
FPV/Y75/8	75	8	51	94	18	214	G	41.600
FPV/Y75/12.5	75	12.5	66	95	21	248	G	52.200
FPV/Y90/8	90	8	58	115	19	251	G	50.800
FPV/Y90/12.5	90	12.5	70	114	25	279	G	75.600
FPV/Y110/8	110	8	61	137	25	283	G	76.800
FPV/Y110/12.5	110	12.5	73	140	30	316	G	115.700
FPV/Y125/8	125	8	68.5	160	35	332	G	151.200
FPV/Y125/12.5	125	12.5	76	159.5	36.5	348	G	236.200
FPV/Y140/8	140	8	72	174	32	348	G	244.800
FPV/Y140/12.5	140	12.5	80	178	37	375	G	372.100
FPV/Y160/10	160	10	77	198	37	388	G	348.500
FPV/Y160/12.5	160	12.5	90	203.5	43.5	427	G	524.500
FPV/Y180/10	180	10	105	232	56	498	G	519.800
FPV/Y200/8	200	8	106	250	52	524	G	720.500
FPV/Y200/10	200	10	115	252	52	534	G	992.100
FPV/Y225/10	225	10	118.5	284.7	77	599	G	1.158.000
FPV/Y250/10	250	10	131	315	87	664	G	2.120.000
FPV/Y280/8	280	8	146	354	96	742	G	2.411.000
FPV/Y315/8	315	8	163.5	394	93	845.5	G	2.590.000

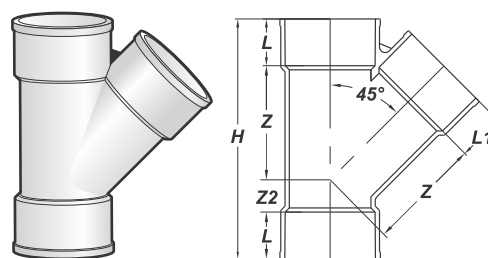

Kiểu G

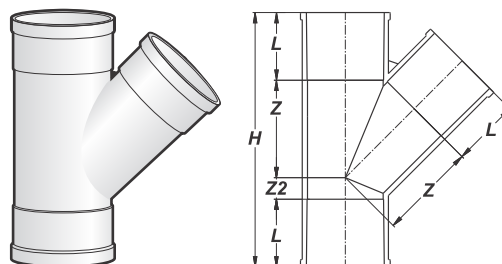

Kiểu G

 Mã trên là mã sản phẩm màu ghi. Muốn đặt sản phẩm màu trắng thêm **WH** vào cuối. VD: Mã **FPV/T75/8** sẽ thành **FPV/T75/8/WH**

Y thu 45° - Reducing Y Pieces 45°

Mã số Code	Kích cỡ Size	PN (Bar)	L	Z	L1	Z1	H	Kiểu dáng Shape	Đơn giá Unit Price (VND/cái)
FPV/YT4834/10	48 x 34	10	34	50	29	52	119	G	9.000
FPV/YT6034/10	60 x 34	10	41	58.3	29	68	139	G	12.200
FPV/YT6042/12.5	60 x 42	12.5	63	63	45	67	191	G	18.100
FPV/YT6048/10	60 x 48	10	48	68.5	42	71	172	G	14.300
FPV/YT7534/10	75 x 34	10	51	65.3	29	70.4	156	G	24.500
FPV/YT7542/10	75 x 42	10	51	71.7	31	74.6	169	G	25.600
FPV/YT7548/10	75 x 48	10	51	78.1	34	81.9	177	G	27.100
FPV/YT7560/10	75 x 60	10	51	86	48	87.5	200	G	36.800
FPV/YT7560/12.5	75 x 60	12.5	66	84	63	86.5	226	G	36.800
FPV/YT9034/10	90 x 34	10	58	82.4	29	83.5	179	G	32.000
FPV/YT9042/10	90 x 42	10	58	87.5	31	87.8	190	G	30.900
FPV/YT9048/8	90 x 48	8	58	89.9	34	94	194	G	31.500
FPV/YT9048/12.5	90 x 48	12.5	70	84.5	55	90	220	G	48.500
FPV/YT9060/10	90 x 60	10	59	94	48	99.5	216	G	39.800
FPV/YT9075/10	90 x 75	10	59	103.7	53	106.5	237	G	49.600
FPV/YT11048/8	110 x 48	8	61	96.3	34	107.5	198	G	48.200
FPV/YT11048/12.5	110 x 48	12.5	73	96	55	108	227	G	67.900
FPV/YT11060/10	110 x 60	10	61	103.8	48	114	220	G	54.100
FPV/YT11060/12.5	110 x 60	12.5	73	104	63	114	245	G	71.900
FPV/YT11075/10	110 x 75	10	61	111	51	122.1	232.6	G	68.500
FPV/YT11090/10	110 x 90	10	61	126.7	59	130	265	G	72.800
FPV/YT11090/12.5	110 x 90	12.5	73	126	70	129	288	G	80.500
FPV/YT12548/10	125 x 48	10	68.5	104	42	121.6	220	G	74.100
FPV/YT12548/12.5	125 x 48	12.5	76	105	55	121	237	G	94.800
FPV/YT12560/10	125 x 60	10	68.5	114.3	48	126.5	240	G	77.800
FPV/YT12575/10	125 x 75	10	68.5	123.7	53	135	260	G	98.000
FPV/YT12575/12.5	125 x 75	12.5	76	123	66	134	274	G	153.600
FPV/YT12590/10	125 x 90	10	68.5	153.2	59	141.5	280	G	106.600
FPV/YT12590/12.5	125 x 90	12.5	76	133.5	70	141	295	G	112.800
FPV/YT125110/12.5	125 x 110	12.5	76	148	73	151	323	G	123.100
FPV/YT14090/10	140 x 90	10	76	142.7	59	153.5	302	G	155.900
FPV/YT14090/12.5	140 x 90	12.5	80	142.5	70	153	305	G	231.600
FPV/YT140110/8	140 x 110	8	72	148.7	61	158.8	302.8	G	165.200
FPV/YT140110/12.5	140 x 110	12.5	80	156.5	73	163	334	G	263.300
FPV/YT16090/10	160 x 90	10	86	153.7	59	167.3	325	G	173.000
FPV/YT160110/10	160 x 110	10	77	161.7	61	172	317	G	302.500
FPV/YT160110/12.5	160 x 110	12.5	90	168	73	178.5	356	G	346.000
FPV/YT160125/12.5	160 x 125	12.5	90	178.5	76	186	377	G	310.500
FPV/YT160140/10	160 x 140	10	77	186.2	72	188.5	362	G	268.600
FPV/YT20090/10	200 x 90	10	106	176.7	59	197.5	365	G	380.200
FPV/YT20090/12.5	200 x 90	12.5	115	174	70	197	378	G	559.500
FPV/YT200110/10	200 x 110	10	106	190.8	61	207.5	392	G	422.800
FPV/YT200110/12.5	200 x 110	12.5	115	188	73	207	406	G	447.600
FPV/YT200125/10	200 x 125	10	106	200.5	68.5	216	415	G	461.800
FPV/YT200125/12.5	200 x 125	12.5	115	198	76	214	427	G	484.800
FPV/YT200140/10	200 x 140	10	106	210.7	76	223.4	435	G	488.900
FPV/YT200160/10	200 x 160	10	106	225.3	86	233.5	465	G	513.900
FPV/YT225160/10	225 x 160	10	118.5	238.7	86	252.5	495	G	850.300
FPV/YT250125/10	250 x 125	10	131	229.5	68.5	252.8	470	G	850.300
FPV/YT250160/10	250 x 160	10	131	253.2	86	269.3	520	G	850.300
FPV/YT250200/10	250 x 200	10	131	282.5	106	291.3	575	G	910.000

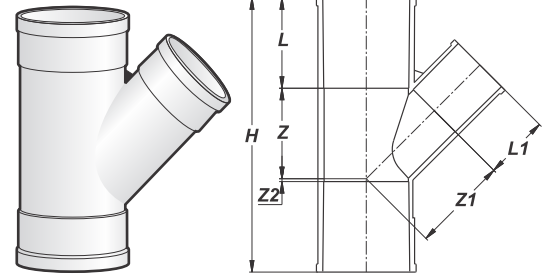

Kiểu G

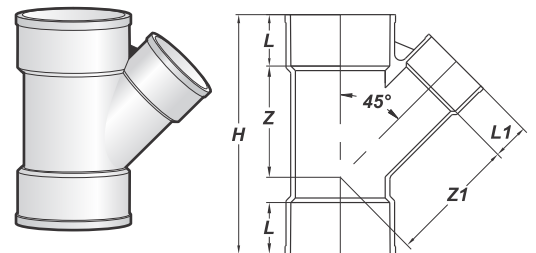

Kiểu G

Tê 91.5° - Tee 91.5°

Mã số Code	Kích cỡ Size	PN (Bar)	L	Z	Z1	Z2	H	Kiểu dáng Shape	Đơn giá Unit Price (VND/cái)
FPV/T34/10	34	10	29	17	23	20	95.5	G	5.200
FPV/T42/10	42	10	31	21	29	25.5	107.5	G	7.500
FPV/T48/10	48	10	34	24	34	31	123.8	G	11.100
FPV/T60/10	60	10	41	30	39	37	149	G	18.300
FPV/T75/10	75	10	51	37	47.5	45	183.8	G	44.800
FPV/T90/10	90	10	58	56	59	55	217.6	G	70.900
FPV/T110/10	110	10	61	55	68	65	242	G	96.900
FPV/T140/10	140	10	72	71	86	82	296	G	216.000
FPV/T160/6	160	6	82	82	96	90	340	G	198.500
FPV/T160/10	160	10	77	82	96	90	327	G	319.300

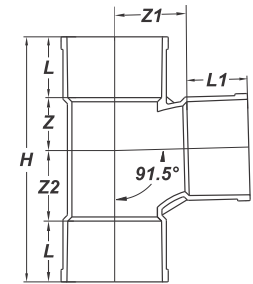
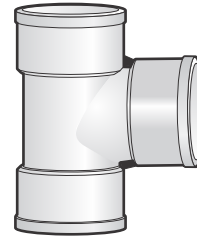

Kiểu G

Tê 91.5° có cửa kiểm tra - Tee 91.5° with Inspection Hole

Mã số Code	Kích cỡ Size	PN (Bar)	L	Z1	M	H	Kiểu dáng Shape	Đơn giá Unit Price (VND/cái)
FPV/TC75/10	75	10	51	47.5	M60 x 2	183.8	G	33.600
FPV/TC90/10	90	10	58	59	M60 x 2	217.6	G	50.000
FPV/TC110/10	110	10	61	68	M90 x 2.5	242	G	85.100
FPV/TC140/10	140	10	72	86	M90 x 2.5	296	G	215.000
FPV/TC160/10	160	10	77	96	M90 x 2.5	327	G	235.000

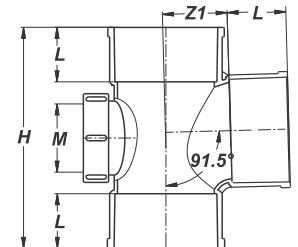
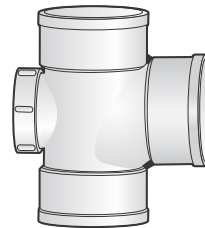

Kiểu G

Tê thu 91.5° - Reducing Tee 91.5°

Mã số Code	Kích cỡ Size	PN (Bar)	L	Z	L1	Z1	Z2	H	Kiểu dáng Shape	Đơn giá Unit Price (VND/cái)
FPV/TT4234/10	42 x 34	10	31	21	29	29.4	22.6	110	G	6.800
FPV/TT4834/10	48 x 34	10	34	17	29	34	23.1	108.8	G	9.000
FPV/TT4842/10	48 x 42	10	34	24	31	33	32	124	G	11.500
FPV/TT6034/10	60 x 34	10	41	17.1	29	38.5	23.6	126	G	14.000
FPV/TT6042/10	60 x 42	10	41	21.3	31	33.4	28	137	G	15.500
FPV/TT6048/10	60 x 48	10	41	26	34	45	34	144	G	16.200
FPV/TT7534/10	75 x 34	10	51	16	29	46.4	24.3	156	G	21.300
FPV/TT7542/10	75 x 42	10	51	20.4	31	46.8	28.4	162	G	22.800
FPV/TT7548/10	75 x 48	10	51	22.5	34	47	31.5	158	G	25.800
FPV/TT7560/10	75 x 60	10	51	29	41	47.3	37.6	172	G	28.800
FPV/TT9034/10	90 x 34	10	58	18.3	29	51.5	25.8	162	G	41.200
FPV/TT9042/10	90 x 42	10	58	23.1	31	53	30.1	170	G	42.300
FPV/TT9048/10	90 x 48	10	58	25.8	34	57.6	33.6	178	G	42.300
FPV/TT9060/10	90 x 60	10	58	31.7	41	57.9	39.6	191	G	47.000
FPV/TT9075/10	90 x 75	10	58	38.9	51	58.4	47.4	204	G	57.000
FPV/TT11048/10	110 x 48	10	61	23.8	34	65.9	32.8	194	G	64.800
FPV/TT11060/10	110 x 60	10	61	35	41	71.6	32.8	196	G	76.500
FPV/TT11075/10	110 x 75	10	61	37.3	51	66.7	48	221	G	80.900
FPV/TT11090/10	110 x 90	10	61	43.7	58	67.2	55.2	223	G	96.900
FPV/TT14090/10	140 x 90	10	72	43.7	58	67.2	55.2	253.5	G	190.200
FPV/TT140110/10	140 x 110	10	72	43.7	61	67.2	55.2	275	G	198.000
FPV/TT160110/10	160 x 110	10	77	56.7	61	94.4	64.6	275.5	G	270.000
FPV/TT200110/10	200 x 110	10	82	58.7	61	133	89	318	G	637.100
FPV/TT200160/10	200 x 160	10	82	83.6	77	135.1	115.6	340	G	691.500

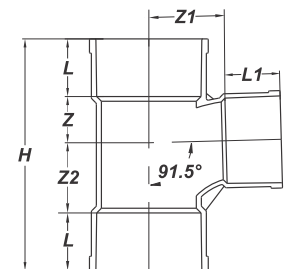
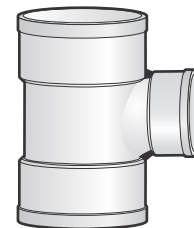

Kiểu G

 Mã trên là mã sản phẩm màu ghi. Muốn đặt sản phẩm màu trắng thêm **WH** vào cuối. VD: Mã **FPV/T75/8** sẽ thành **FPV/T75/8/WH**

Cút cong có lỗ treo giữ cút - Circular Bottom Trap

Mã số Code	Kích cỡ Size	PN (Bar)	L	Z	R	Kiểu dáng Shape	Đơn giá Unit Price (VND/cái)
FPV/C42/10	42	10	31	53	40.9	G	7.800
FPV/C48/10	48	10	32	61	46.5	G	10.200
FPV/C60/10	60	10	41	75	58.2	G	27.100
FPV/C75/10	75	10	51	94	73.4	G	29.800
FPV/C90/10	90	10	58	113	87.8	G	45.800
FPV/C110/10	110	10	61	137	107.8	G	60.800

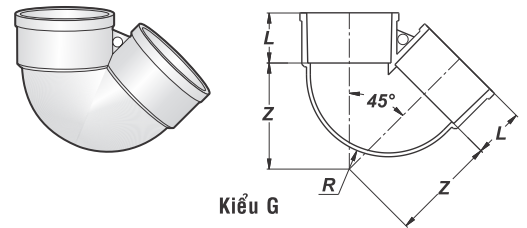

Kiểu G

Cút cong có cửa kiểm tra và lỗ treo giữ cút - Circular Bottom Trap with Inspection Hole

Mã số Code	Kích cỡ Size	PN (Bar)	L	Z	R	M	Kiểu dáng Shape	Đơn giá Unit Price (VND/cái)
FPV/CC42/10	42	10	31	53	40.9	M30 x 2	G	10.200
FPV/CC48/10	48	10	34	61	46.5	M30 x 2	G	13.800
FPV/CC60/10	60	10	41	75	58.2	M30 x 2	G	35.500
FPV/CC75/10	75	10	51	94	73.4	M60 x 2	G	37.500
FPV/CC90/10	90	10	58	113	87.8	M60 x 2	G	60.300
FPV/CC110/10	110	10	61	137	107.8	M90 x 2.5	G	80.900

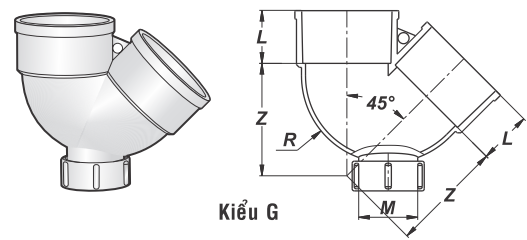

Kiểu G

Cút cong có cửa kiểm tra loại dài - Circular Bottom Trap - Long Type

Mã số Code	Kích cỡ Size	PN (Bar)	L	Z	Z2	R	M	Kiểu dáng Shape	Đơn giá Unit Price (VND/cái)
FPV/CLC42/10	42	10	35	80	52	41	M30 x 2	G	11.200
FPV/CLC48/10	48	10	33	94	60	45	M30 x 2	G	15.200
FPV/CLC60/10	60	10	41	105	74	58	M30 x 2	G	39.000
FPV/CLC75/10	75	10	51	128	93	76	M60 x 2	G	41.200
FPV/CLC90/10	90	10	56	154	113	90	M60 x 2	G	66.300
FPV/CLC110/10	110	10	61	190	140	110	M90 x 2	G	88.900

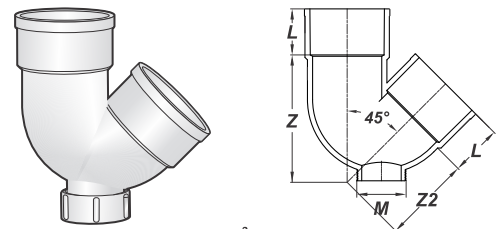

Kiểu G

Bạc chuyển bậc đồng tâm - Reducing Bushes

Mã số Code	Kích cỡ Size	PN (Bar)	L	H	Kiểu dáng Shape	Đơn giá Unit Price (VND/cái)
FPV/CBD4227/12.5	42 x 27	12.5	45	47	T	3.900
FPV/CBD4234/12.5	42 x 34	12.5	45	47	T	3.900
FPV/CBD4827/10	48 x 27	10	16	27	T	5.600
FPV/CBD4827/12.5	48 x 27	12.5	16	27	T	6.200
FPV/CBD4834/12.5	48 x 34	12.5	21	27	T	6.900
FPV/CBD4842/12.5	48 x 42	12.5	25	27	T	6.900
FPV/CBD6027/12.5	60 x 27	12.5	16	34	T	9.600
FPV/CBD6034/12.5	60 x 34	12.5	21	34	T	10.600
FPV/CBD6042/12.5	60 x 42	12.5	26	34	T	10.800
FPV/CBD6048/12.5	60 x 48	12.5	29	34	T	8.800
FPV/CBD7534/12.5	75 x 34	12.5	21	43	T	9.900
FPV/CBD7542/12.5	75 x 42	12.5	26	43	T	9.900
FPV/CBD7548/12.5	75 x 48	12.5	29	43	T	9.900
FPV/CBD7560/12.5	75 x 60	12.5	37	43	T	9.900
FPV/CBD9042/12.5	90 x 42	12.5	26	50	T	15.100
FPV/CBD9048/12.5	90 x 48	12.5	29	50	T	16.000
FPV/CBD9060/12.5	90 x 60	12.5	37	50	T	17.100
FPV/CBD9075/12.5	90 x 75	12.5	46	50	T	15.200
FPV/CBD11034/12.5	110 x 34	12.5	21	62	T	23.400
FPV/CBD11042/12.5	110 x 42	12.5	26	62	T	26.900
FPV/CBD11048/12.5	110 x 48	12.5	29	62	T	30.000
FPV/CBD11060/12.5	110 x 60	12.5	37	62	T	31.200
FPV/CBD11075/12.5	110 x 75	12.5	46	62	T	33.400
FPV/CBD11090/12.5	110 x 90	12.5	55	62	T	33.500
FPV/CBD12548/12.5	125 x 48	12.5	29	71	T	42.000
FPV/CBD12560/12.5	125 x 60	12.5	37	71	T	42.000
FPV/CBD12575/12.5	125 x 75	12.5	46	71	T	48.000
FPV/CBD12590/12.5	125 x 90	12.5	55	71	T	48.000
FPV/CBD125110/12.5	125 x 110	12.5	68	71	T	48.000
FPV/CBD14075/12.5	140 x 75	12.5	46	80	T	41.800
FPV/CBD14090/12.5	140 x 90	12.5	55	80	T	55.100
FPV/CBD140110/12.5	140 x 110	12.5	68	80	T	55.100
FPV/CBD140125/12.5	140 x 125	12.5	75	80	T	55.100
FPV/CBD16048/12.5	160 x 48	12.5	29	89.5	T	80.200
FPV/CBD16060/12.5	160 x 60	12.5	37	89.5	T	80.200
FPV/CBD16075/12.5	160 x 75	12.5	46	89.5	T	80.200
FPV/CBD16090/12.5	160 x 90	12.5	55	89.5	T	82.800
FPV/CBD160110/12.5	160 x 110	12.5	68	89.6	T	90.800
FPV/CBD160125/12.5	160 x 125	12.5	75	89.6	T	90.800
FPV/CBD160140/12.5	160 x 140	12.5	85	89.6	T	90.800
FPV/CBD20090/12.5	200 x 90	12.5	65.5	101.5	T	156.200
FPV/CBD200110/12.5	200 x 110	12.5	56.5	101.5	T	161.300
FPV/CBD200125/12.5	200 x 125	12.5	71.5	101.5	T	161.300
FPV/CBD200140/12.5	200 x 140	12.5	75.5	101.5	T	161.300
FPV/CBD200160/12.5	200 x 160	12.5	101.5	101.5	T	161.300
FPV/CBD225200/12.5	225 x 200	12.5	115.5	130.6	T	252.200
FPV/CBD250200/12.5	250 x 200	12.5	120.5	145.7	T	303.500
FPV/CBD250225/12.5	250 x 225	12.5	130	145.7	T	327.600

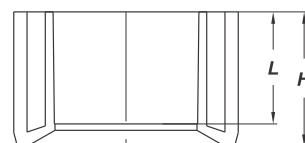
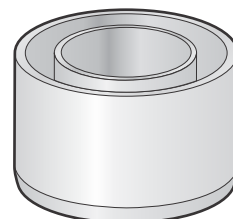

Kiểu T

 Mã trên là mã sản phẩm màu ghi. Muốn đặt sản phẩm màu trắng thêm **WH** vào cuối. VD: Mã **FPV/T75/8** sẽ thành **FPV/T75/8/WH**

Đầu bịt - End Cap

Mã số Code	Kích cỡ Size	PN (Bar)	L	H	Kiểu dạng Shape	Đơn giá Unit Price (VND/cái)
FPV/DB21/16	21	16	30	33.5	T	1.100
FPV/DB27/16	27	16	35	38.5	T	1.800
FPV/DB34/8	34	8	22	23.9	T	2.000
FPV/DB34/12.5	34	12.5	40	42.5	T	2.900
FPV/DB42/8	42	8	25	27.3	T	2.500
FPV/DB42/12.5	42	12.5	45	47.9	T	4.800
FPV/DB48/8	48	8	26	28.6	T	3.500
FPV/DB48/12.5	48	12.5	55	58.3	T	3.500
FPV/DB60/8	60	8	32	35.3	T	8.800
FPV/DB60/12.5	60	12.5	63	67.2	T	10.600
FPV/DB75/8	75	8	40	44	T	11.000
FPV/DB75/12.5	75	12.5	66	71	T	14.100
FPV/DB90/8	90	8	46	50.7	T	11.800
FPV/DB90/12.5	90	12.5	70	75.9	T	23.800
FPV/DB110/8	110	8	48	53.8	T	24.500
FPV/DB110/12.5	110	12.5	73	80.3	T	35.500
FPV/DB125/8	125	8	52	58.6	T	29.800
FPV/DB125/12.5	125	12.5	76	84.1	T	52.800
FPV/DB140/8	140	8	56	63.4	T	30.800
FPV/DB140/12.5	140	12.5	80	89.1	T	66.500
FPV/DB160/8	160	8	60	68.5	T	61.000
FPV/DB160/12.5	160	12.5	90	100.5	T	116.000
FPV/DB200/10	200	10	86	92.5	T	338.100
FPV/DB225/10	225	10	92.7	103.5	T	358.000
FPV/DB250/10	250	10	99	108	T	485.300
FPV/DB280/10	280	10	110	121	T	912.600
FPV/DB315/8	315	8	130	142	T	1.834.000

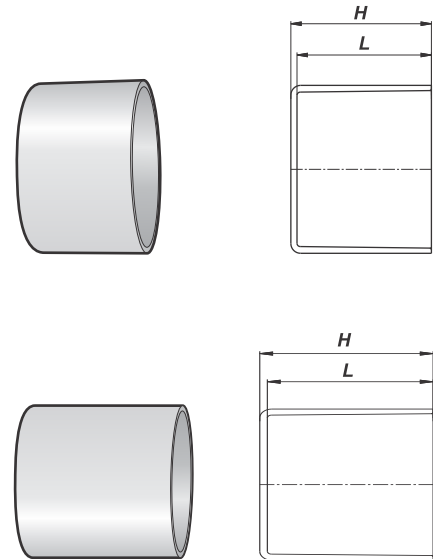

Kiểu T

Bịt xả thông tắc - Flange Clean Out

Mã số Code	Kích cỡ Size	PN (Bar)	L	H	Đơn giá Unit Price (VND/cái)
FPV/BX60/10	60	10	36	44	11.800
FPV/BX75/10	75	10	44	52	17.100
FPV/BX90/10	90	10	51	78	24.900
FPV/BX110/10	110	10	61	60	33.000
FPV/BX125/10	125	10	68	71	47.300
FPV/BX140/10	140	10	76	87	62.600
FPV/BX160/10	160	10	86	98	83.900
FPV/BX200/10	200	10	-	115	397.800

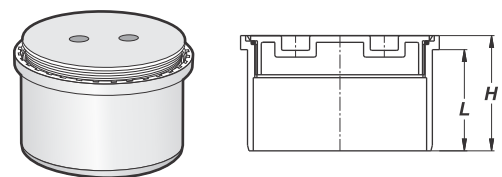

Nối thẳng 2 đầu ren ngoài - Hexagon Nipples

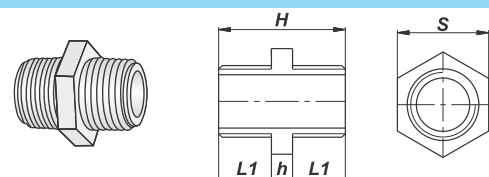
Mã số Code	Kích cỡ Size	PN (Bar)	L1	S	h	H	Đơn giá Unit Price (VND/cái)
FPV/HN1/2	1/2"	-	-	-	-	-	1.500
FPV/HN3/4	3/4"	-	-	-	-	-	2.200
FPV/HN1	1"	-	-	-	-	-	4.000

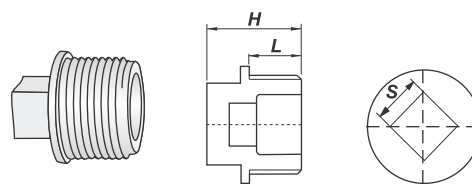

Đầu bịt ren ngoài - Male Cap

Mã số Code	Kích cỡ Size	L	S	H	Đơn giá Unit Price (VND/cái)
FPV/MC1/2	1/2"	12.5	20	21.4	700
FPV/MC3/4	3/4"	14	20	23.8	1.200
FPV/MC1	1"	-	-	-	2.000

Nối thẳng ren trong - Adaptor Sockets

Mã số Code	Kích cỡ Size	PN (Bar)	L	L1	h	H	Đơn giá Unit Price (VND/cái)
FPV/AS21x1/2/10	21 x 1/2"	10	18.5	17.5	6	36	1.300
FPV/AS27x1/2/10	27 x 1/2"	10	21	19	8	40	1.800
FPV/AS27x3/4/10	27 x 3/4"	10	21	19	8	40	18.00
FPV/AS34x3/4/10	34 x 3/4"	10	40	23	4	63	2.800
FPV/AS34x1/10	34 x 1"	10	26	21	8	47	3.100
FPV/AS42x1 1/4/10	42 x 1 1/4"	10	30	24	10	54	4.000
FPV/AS48x1 1/2/10	48 x 1 1/2"	10	33	24	10	57	5.900
FPV/AS60x2/6	60 x 2"	6	36	29	10	68	8.500
FPV/AS60x2/10	60 x 2"	10	39	28	12	67	9.500

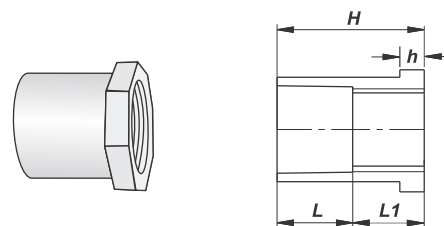
Nối thẳng ren trong (ren đồng) - Adaptor Sockets (with brass thread)

Mã số Code	Kích cỡ Size	PN (Bar)	L	H	S	Đơn giá Unit Price (VND/cái)
FPV/ASU21x1/2/16	21 x 1/2"	16	30	49	30	10.500
FPV/ASU27x1/2/16	27 x 1/2"	16	35	53.5	35	14.500
FPV/ASU27x3/4/16	27 x 3/4"	16	35	56	37	14.500
FPV/ASU34x3/4/16	34 x 3/4"	16	-	-	-	18.800
FPV/ASU34x1/16	34 x 1"	16	-	-	-	18.800

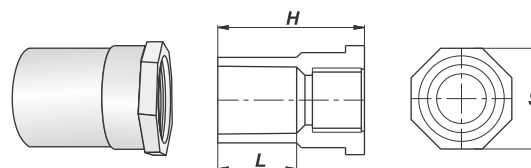
Nối thẳng ren ngoài - Adaptor Bushes Equal

Mã số Code	Kích cỡ Size	PN (Bar)	L	L1	h	H	Đơn giá Unit Price (VND/cái)
FPV/AE21x1/2/10	21 x 1/2"	10	20	15	6	39	1.300
FPV/AE21x1/10	21 x 1"	10	20	20	8	44	1.300
FPV/AE27x1/2/10	27 x 1/2"	10	35	17	8	56	1.800
FPV/AE27x3/4/10	27 x 3/4"	10	21	17	8	42	1.800
FPV/AE27x1/10	27 x 1"	10	21	20	8	48	1.800
FPV/AE27x1 1/2/10	27 x 1 1/2"	10	21	22	10	56.7	1.800
FPV/AE34x3/4/10	34 x 3/4"	10	40	19	8	63	2.800
FPV/AE34x1/10	34 x 1"	10	23	19	8	47	3.100
FPV/AE34x1 1/2/10	34 x 1 1/2"	10	23	22	10	59	3.100
FPV/AE42x1 1/4/10	42 x 1 1/4"	10	30	22	10	58	4.300
FPV/AE48x1 1/2/10	48 x 1 1/2"	10	33	22	10	61	5.900
FPV/AE60x2/10	60 x 2"	10	39	26	12	72	9.500

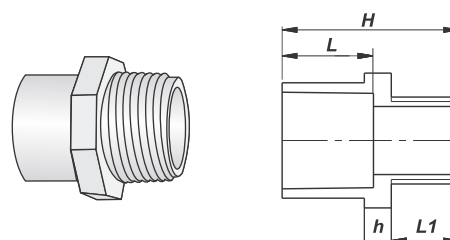

Mã trên là mã sản phẩm màu ghi. Muốn đặt sản phẩm màu trắng thêm **WH** vào cuối. VD: Mã **FPV/T75/8** sẽ thành **FPV/T75/8/WH**

Nối thẳng ren ngoài (ren đồng) - Adaptor Bushes Equal (with brass thread)

Mã số Code	Kích cỡ Size	PN (Bar)	L	L1	S	H	Đơn giá Unit Price (VND/cái)
FPV/AEU21x1/2/16	21 x 1/2"	16	30	-	30	49	8.900
FPV/AEU27x1/2/16	27 x 1/2"	16	35	-	35	53.5	12.600
FPV/AEU27x3/4/16	27 x 3/4"	16	35	-	37	56	12.600

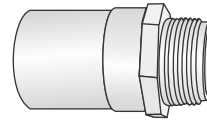
Nối góc 90° ren trong - Female Thread Elbows 90°

Mã số Code	Kích cỡ Size	PN (Bar)	L	Z	L1	Z1	Đơn giá Unit Price (VND/cái)
FPV/FE21x1/2/10	21 x 1/2"	10	21	11	20	10	2.500
FPV/FE27x1/2	27 x 1/2"	-	-	-	-	-	3.100
FPV/FE27x3/4/10	27 x 3/4"	10	22.5	17	22	12	3.200
FPV/FE34x3/4	34 x 3/4"	-	-	-	-	-	6.600
FPV/FE34x1	34 x 1"	-	-	-	-	-	6.600

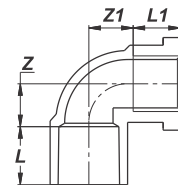
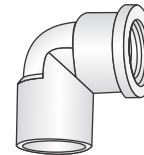
Nối góc 90° ren trong (ren đồng) - Faucet Elbows 90° (with brass thread)

Mã số Code	Kích cỡ Size	PN (Bar)	L	Z	H	Đơn giá Unit Price (VND/cái)
FPV/FEU21x1/2/16	21 x 1/2"	16	30	10	32	11.300
FPV/FEU27x1/2/16	27 x 1/2"	16	35	12	35	15.000
FPV/FEU27x3/4/16	27 x 3/4"	16	35	16	33.5	17.900
FPV/FEU34x1/2/16	34 x 1/2"	16	40	19.5	38	18.800
FPV/FEU34x3/4/16	34 x 3/4"	16	40	19	37.5	26.000
FPV/FEU34x1	34 x 1"	-	-	-	-	26.000

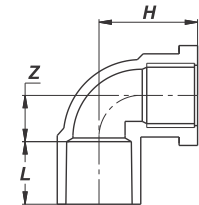
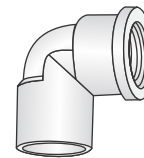
Nối góc 90° ren ngoài - Male Thread Elbows 90°

Mã số Code	Kích cỡ Size	PN (Bar)	L	Z	L1	H1	Đơn giá Unit Price (VND/cái)
FPV/ME21x1/2/10	21 x 1/2"	10	30	13	17	26	2.100
FPV/ME27x1/2/10	27 x 1/2"	10	35	16	17	34	3.500
FPV/ME34x1/10	34 x 1"	10	40	22	21	41	3.500

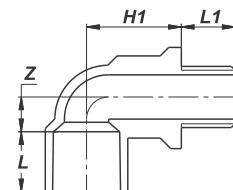
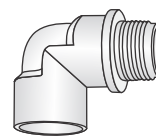
Nối góc 90° ren ngoài (ren đồng) - Male Thread Elbows 90° (with brass thread)

Mã số Code	Kích cỡ Size	PN (Bar)	L	Z	L1	H1	Đơn giá Unit Price (VND/cái)
FPV/MEU21x1/2/16	21 x 1/2"	16	30	10	-	-	8.800
FPV/MEU27x1/2/16	27 x 1/2"	16	35	12	-	-	15.500
FPV/MEU27x3/4/16	27 x 3/4"	16	34	16	-	-	15.500
FPV/MEU34x1/2/16	34 x 1/2"	16	40	19.5	-	38	18.800
FPV/MEU34x3/4/16	34 x 3/4"	16	40	19	-	37.5	27.800
FPV/MEU34x1/16	34 x 1"	16	-	-	-	-	30.900

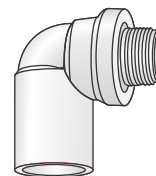

Tê 90° ren trong (ren đồng) - Faucet Tees 90° (with brass thread)

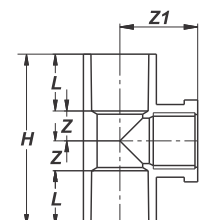
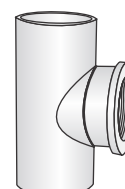
Mã số Code	Kích cỡ Size	PN (Bar)	L	Z	Z1	H	Đơn giá Unit Price (VND/cái)
FPV/FTU21x1/2/16	21 x 1/2"	16	30	10.5	31.5	81	13.400
FPV/FTU27x1/2/16	27 x 1/2"	16	35	10.5	35	90.5	18.900
FPV/FTU27x3/4/16	27 x 3/4"	16	35	10.5	35	90.5	18.900
FPV/FTU34x3/4	34 x 3/4"	-	-	-	-	-	26.300
FPV/FTU34x1	34 x 1"	-	-	-	-	-	26.300

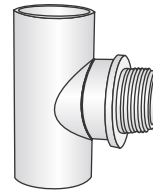

Tê 90° ren ngoài (ren đồng) - Male Thread Tees 90° (with brass thread)

Mã số Code	Kích cỡ Size	PN (Bar)	L	Z	Z1	H	Đơn giá Unit Price (VND/cái)
FPV/MTU21x1/2/16	21 x 1/2"	16	30	10.5	31.5	81	11.600
FPV/MTU27x1/2/16	27 x 1/2"	16	35	10.5	35	90.5	16.300
FPV/MTU27x3/4/16	27 x 3/4"	16	35	10.5	35	90.5	16.300

Bích kép- Van Stone Flange

Mã số Code	Kích cỡ Size	PN (Bar)	L	H	Z	Z1	Đơn giá Unit Price (VND/cái)
FPV/SF60/10	60	10	43	38.5	24	14.3	
FPV/SF75/10	75	10	48	45	27	15	
FPV/SF90/10	90	10	66.5	52	34	19.5	
FPV/SF110/10	110	10	74.5	62.5	35	22	191.800
FPV/SF125/10	125	10	76	71	35	22	243.000
FPV/SF140/10	140	10	85.6	78	36.5	23	
FPV/SF160/10	160	10	105	87.5	45	27.5	341.200
FPV/SF200/10	200	10	132.5	108	64	39	514.500
FPV/SF225/10	225	10	125.6	120	63.5	39.5	886.600
FPV/SF250/10	250	10	156.5	132	63	38	1.312.600
FPV/SF280/10	280	10	165	147	44	35	
FPV/SF315/10	315	10	188.8	163.8	66.7	41.5	
FPV/SF355/10	355	10	204	184	60	45	
FPV/SF400/10	400	10	231	206	61	41.5	

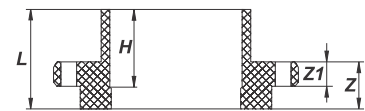
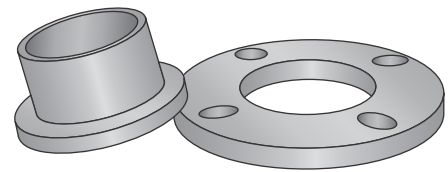
Bích đơn - ST Flange

Mã số Code	Kích cỡ Size	PN (Bar)	L	H	H1	R	Đơn giá Unit Price (VND/cái)
FPV/TSF60/10	60	10	55.5	40.5	16	7	89.500
FPV/TSF75/10	75	10	58	51	18.5	7	124.900
FPV/TSF90/10	90	10	63.5	57.5	22	8.5	124.500
FPV/TSF110/10	110	10	85	64	21	8.5	167.900
FPV/TSF140/10	140	10	102	78	24	8.5	285.800
FPV/TSF160/10	160	10	111.5	88	25	11	400.500
FPV/TSF200/10	200	10	141.5	108	32	11	699.800
FPV/TSF250/10	250	10	151	131	33	11	979.600

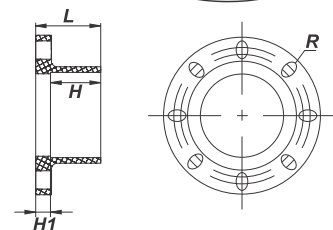
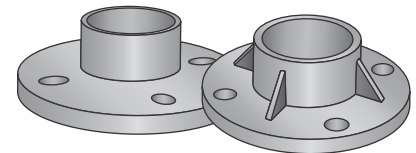

Mã trên là mã sản phẩm màu ghi. Muốn đặt sản phẩm màu trắng thêm **WH** vào cuối. VD: Mã **FPV/T75/8** sẽ thành **FPV/T75/8/WH**

Đai khởi thủy - Tapping Saddle

Mã số Code	Kích cỡ Size	PN (Bar)	H	Z	L	Đơn giá Unit Price (VND/cái)
FPV/TS75x1.5/10	75 x 1.5"	10	24	68	31	
FPV/TS90x25/10	90 x 25"	10	26	80	36	
FPV/TS90x1/10	90 x 1"	10	24	79.5	36	
FPV/TS90x1.5/10	90 x 1.5"	10	24	75	36	
FPV/TS110x1/10	110 x 1"	10	24	88.5	38	
FPV/TS110x1.5/10	110 x 1.5"	10	35	97	38	
FPV/TS110x2/10	110 x 2"	10	35	97	38	
FPV/TS110x2.5/10	110 x 2.5"	10	35	97	38	
FPV/TS125x1.5/10	125 x 1.5"	10	37	105	37	
FPV/TS125x2/10	125 x 2"	10	37	105	37	
FPV/TS125x2.5/10	125 x 2.5"	10	37	105	37	
FPV/TS160x1/10	160 x 1"	10	24	114.5	55	
FPV/TS160x1.5/10	160 x 1.5"	10	36	125	55	
FPV/TS160x2/10	160 x 2"	10	36	125	55	
FPV/TS160x2.5/10	160 x 2.5"	10	36	125	55	
FPV/TS200x1.5/10	200 x 1.5"	10	35	142	74	
FPV/TS200x2/10	200 x 2"	10	37	142	74	
FPV/TS200x2.5/10	200 x 2.5"	10	37	142	74	
FPV/TS225x1.5/10	225 x 1.5"	10	37	153.5	76	
FPV/TS225x2/10	225 x 2"	10	37	153.5	76	
FPV/TS225x2.5/10	225 x 2.5"	10	37	153.5	76	
FPV/TS250x2/10	250 x 2"	10	28	170	76	
FPV/TS250x2.5/10	250 x 2.5"	10	38	170	76	
FPV/TS250x3/10	250 x 3"	10	34	170	76	
FPV/TS250x110/10	250 x 110	10	61.5	195	76	
FPV/TS315x2/10	315 x 2"	10	27	170	70	
FPV/TS315x110/10	315 x 110	10	63	231.5	70	
FPV/TS315x160/10	315 x 160	10	86	250	70	
FPV/TS400x250/10	400 x 250	10	162	385	87	

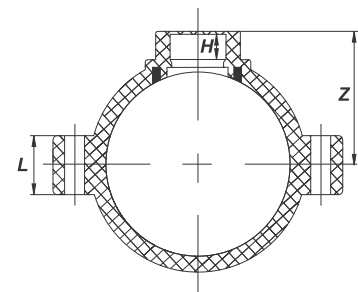
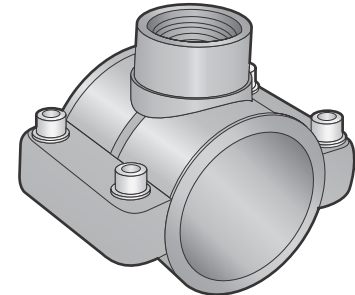
Zắc co - Socket unions

Mã số Code	Kích cỡ Size	PN (Bar)	L	L1	H	Đơn giá Unit Price (VND/cái)
FPV/Z21/8	21	8	25.5	27.5	61.5	8.500
FPV/Z27/8	27	8	31.5	32	72.5	11.800
FPV/Z34/8	34	8	30	36	75	18.600
FPV/Z42/8	42	8	35.5	39.5	86	27.100
FPV/Z48/8	48	8	38.5	42.5	93.5	38.000
FPV/Z60/8	60	8	43	48	105	56.600

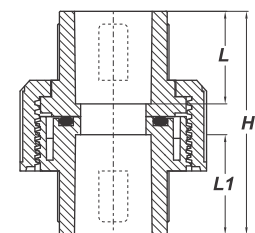
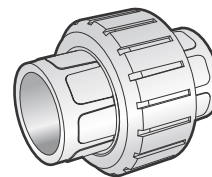

Phễu thu nước góc tường - Corner Drain Leak

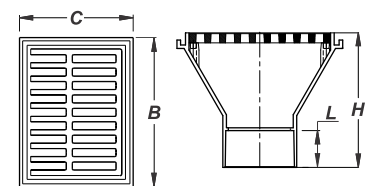
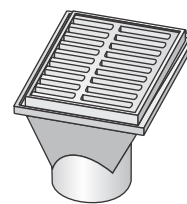
Mã số Code	Kích cỡ Size	PN (Bar)	L	B	C	A	Đơn giá Unit Price (VND/cái)
FPV/PG48/8	48	8	26	117	89	95	33.000
FPV/PG60/8	60	8	32	157	122	113	42.600
FPV/PG75/6	75	6	40	157	122	113	51.300
FPV/PG90/6	90	6	46	188	143	125	66.500
FPV/PG110/6	110	6	48	270	167	130	91.500

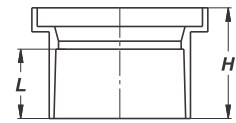
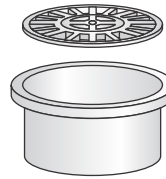

Cửa thoát nước - Floor Drain Leak

Mã số Code	Kích cỡ Size	PN (Bar)	L	H	Đơn giá Unit Price (VND/cái)
FPV/LT48/8	48	8	26	41.5	9.000
FPV/LT75/6	75	6	40	55	13.200
FPV/LT90	90	-	-	-	17.500
FPV/LT110	110	-	-	-	24.600

Phễu thu nước sân thượng/Đầu chụp ống thoát hơi - Roof Leak

Mã số Code	Kích cỡ Size	PN (Bar)	L	L1	H	Đơn giá Unit Price (VND/cái)
FPV/PT75/A/6	75	6	40	117	160	30.800
FPV/PT90/A/6	90	6	46	141	195	33.600
FPV/PT110/A/5	110	5	48	161	225	40.400

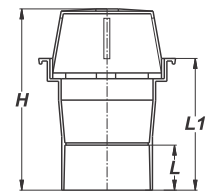
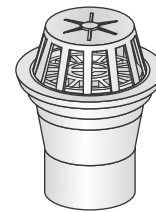
Cút chữ P - P Trap

Mã số Code	Kích cỡ Size	PN (Bar)	L	B	H	Đơn giá Unit Price (VND/cái)
FPV/P42/10	42	10	31	133	85	15.600
FPV/P48/10	48	10	34	146	94.2	21.800
FPV/P60/10	60	10	41	178	113	54.100
FPV/P75/10	75	10	51	222	141	69.300
FPV/P90/10	90	10	58	260	165	101.500
FPV/P110/10	110	10	61	290	186	156.800

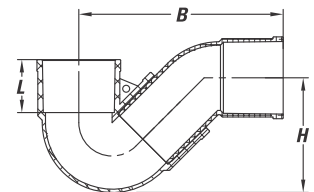
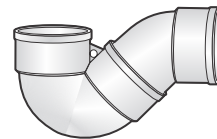
Cút chữ P có cửa kiểm tra - P Trap with Inspection Hole

Mã số Code	Kích cỡ Size	PN (Bar)	L	B	M	H	Đơn giá Unit Price (VND/cái)
FPV/PC42/10	42	10	31	133	M30 x 2	100	19.900
FPV/PC48/10	48	10	34	146	M30 x 2	110	26.100
FPV/PC60/10	60	10	41	178	M30 x 2	129	64.800
FPV/PC75/10	75	10	51	222	M60 x 2	159	79.300
FPV/PC90/10	90	10	58	260	M60 x 2	184	120.000
FPV/PC110/10	110	10	61	290	M90 x 2.5	215	182.800

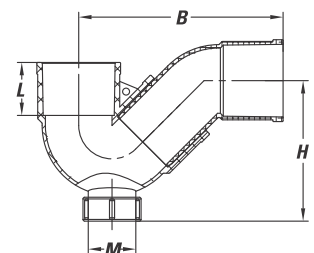
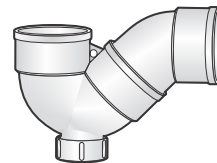

Cút chữ P có cửa kiểm tra loại dài - P Trap with Inspection Hole - Long Type

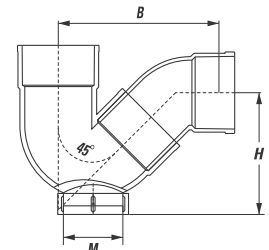
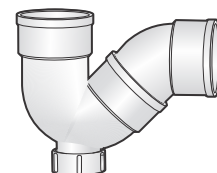
Mã số Code	Kích cỡ Size	PN (Bar)	B	M	H	Đơn giá Unit Price (VND/cái)
FPV/PCL42/10	42	10	120	M30 x 2	78	-
FPV/PCL48/10	48	10	137	M30 x 2	90	-
FPV/PCL60/10	60	10	168	M30 x 2	106	-
FPV/PCL75/10	75	10	200	M60 x 2	122	-
FPV/PCL90/10	90	10	232	M60 x 2	148	-
FPV/PCL110/10	110	10	270	M90 x 2.5	173	-

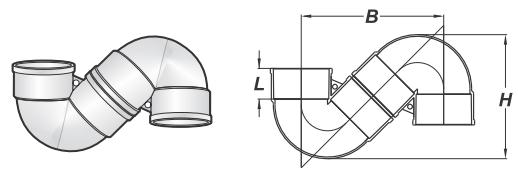

Cút chữ S - S Trap

Mã số Code	Kích cỡ Size	PN (Bar)	L	B	H	Đơn giá Unit Price (VND/cái)
FPV/S42/10	42	10	31	121	109	20.800
FPV/S48/10	48	10	34	137	122	27.500
FPV/S60/10	60	10	41	166	147	72.000
FPV/S75/10	75	10	51	207	183	80.200
FPV/S90/10	90	10	58	244	215	122.500
FPV/S110/10	110	10	61	284	247	163.500

Cút chữ S có cửa kiểm tra - S Trap with Inspection Hole

Mã số Code	Kích cỡ Size	PN (Bar)	L	B	H	M	Đơn giá Unit Price (VND/cái)
FPV/SC42/10	42	10	31	121	124	M30 x 2	24.200
FPV/SC48/10	48	10	34	137	138	M30 x 2	32.000
FPV/SC60/10	60	10	41	166	164	M30 x 2	83.000
FPV/SC75/10	75	10	51	207	201	M60 x 2	90.200
FPV/SC90/10	90	10	58	244	234	M60 x 2	141.100
FPV/SC110/10	110	10	61	284	276	M90 x 2.5	188.800

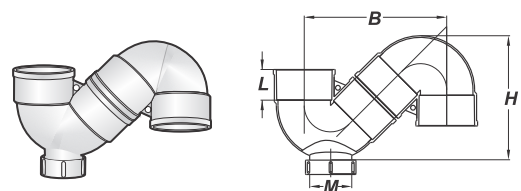
Cút chữ S có cửa kiểm tra loại dài - S Trap with Inspection Hole - Long Type

Mã số Code	Kích cỡ Size	PN (Bar)	B	M	H	Đơn giá Unit Price (VND/cái)
FPV/SCL42/10	42	10	106	M30 x 2	100	-
FPV/SCL48/10	48	10	122	M30 x 2	114	-
FPV/SCL60/10	60	10	153	M30 x 2	143	-
FPV/SCL75/10	75	10	210	M60 x 2	202	-
FPV/SCL90/10	90	10	252	M60 x 2	242	-
FPV/SCL110/10	110	10	307	M90 x 2.5	296	-

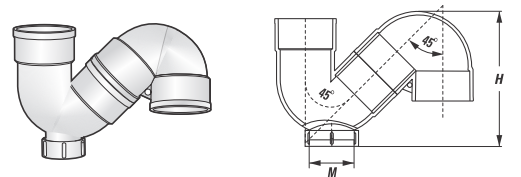
Cút chữ S có 2 cửa kiểm tra - S Trap with 2 Inspection Hole

Mã số Code	Kích cỡ Size	PN (Bar)	L	B	H	M	Đơn giá Unit Price (VND/cái)
FPV/S2C42/10	42	10	31	121	139	M30 x 2	27.500
FPV/S2C48/10	48	10	34	137	154	M30 x 2	36.800
FPV/S2C60/10	60	10	41	166	180	M30 x 2	94.500
FPV/S2C75/10	75	10	51	207	220	M60 x 2	100.000
FPV/S2C90/10	90	10	58	244	254	M60 x 2	160.300
FPV/S2C110/10	110	10	61	284	304	M90 x 2.5	214.800

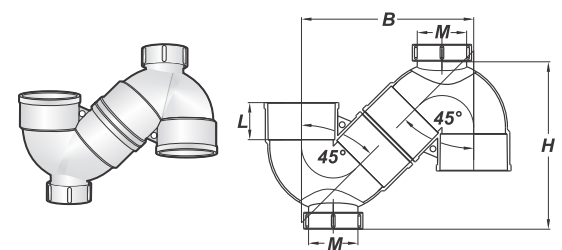

Cút chữ S có 2 cửa kiểm tra loại dài - S Trap with 2 Inspection Hole - Long Type

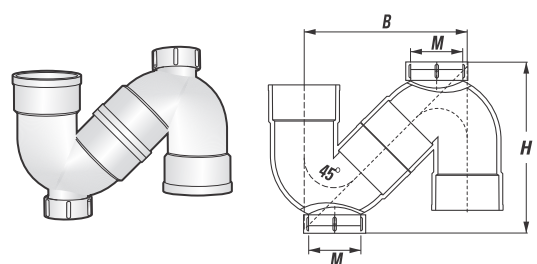
Mã số Code	Kích cỡ Size	PN (Bar)	B	M	H	Đơn giá Unit Price (VND/cái)
FPV/S2CL42/10	42	10	106	M30 x 2	100	-
FPV/S2CL48/10	48	10	122	M30 x 2	114	-
FPV/S2CL60/10	60	10	153	M30 x 2	143	-
FPV/S2CL75/10	75	10	210	M60 x 2	202	-
FPV/S2CL90/10	90	10	252	M60 x 2	242	-
FPV/S2CL110/10	110	10	307	M90 x 2.5	296	-

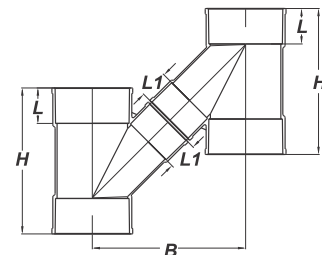
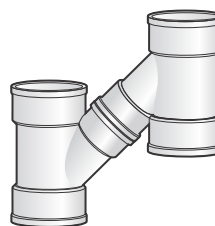

Cút nối chữ H - H-Type Connector

Mã số Code	Kích cỡ Size	PN (Bar)	L	L1	B	H	Đơn giá Unit Price (VND/cái)
FPV/H11048/10	110 x 48	10	61	34	202	199	
FPV/H11060/10	110 x 60	10	61	41	225	208	
FPV/H11075/10	110 x 75	10	61	51	247	234	
FPV/H11090/10	110 x 90	10	61	58	272	264	
FPV/H110110/10	110 x 110	10	61	61	285	284	
FPV/H160110/10	160 x 110	10	77	61	333	317	
FPV/H160140/10	160 x 140	10	77	72	373	362	
FPV/H160160/10	160 x 160	10	77	77	393	389	

Tê có chốt co giãn - Tee with Flexible Coupling

Mã số Code	Kích cỡ Size	PN (Bar)	L	Z	H	Đơn giá Unit Price (VND/cái)
FPV/TG48/10	48	10	34	34	194.5	
FPV/TG60/10	60	10	41	39	232	
FPV/TG75/10	75	10	51	47.5	288.5	
FPV/TG90/10	90	10	58	59	334.5	
FPV/TG110/10	110	10	61	68	368.5	
FPV/TG140/10	140	10	72	86	442.5	
FPV/TG160/10	160	10	77	96	480	

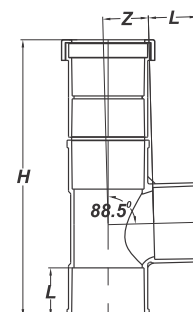
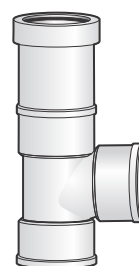
Nối thẳng có cửa kiểm tra và chốt co giãn - Inspection Coupling with Inspection Hole & Flexible Coupling

Mã số Code	Kích cỡ Size	PN (Bar)	L	M	H	Đơn giá Unit Price (VND/cái)
FPV/NCG48/10	48	10	34	M30 x 2	187.5	
FPV/NCG60/10	60	10	41	M30 x 2	214	
FPV/NCG75/10	75	10	51	M60 x 2	276.5	
FPV/NCG90/10	90	10	58	M60 x 2	309.5	
FPV/NCG110/10	110	10	61	M90 x 2.5	353.5	
FPV/NCG140/10	140	10	72	M90 x 2.5	393.5	
FPV/NCG160/10	160	10	77	M90 x 2.5	415	

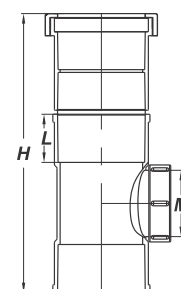
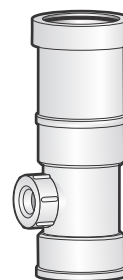
Ống kết hợp (Làm giảm áp lực của nước) - Combined Standing Pipes (for Energy Dissipating)

Mã số Code	Kích cỡ Size	PN (Bar)	L	B	M	H	Đơn giá Unit Price (VND/cái)
FPV/KH110/10	110	10	61	247	M90 x 2.5	830	
FPV/KH140/10	140	10	72	305	M90 x 2.5	975	
FPV/KH160/10	160	10	77	339	M90 x 2.5	1044	

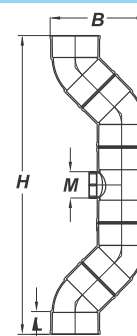
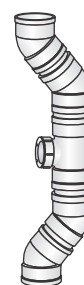

Mã trên là mã sản phẩm màu ghi. Muốn đặt sản phẩm màu trắng thêm **WH** vào cuối. VD: Mã **FPV/T75/8** sẽ thành **FPV/T75/8/WH**

Vòng sắt ngăn lửa (màu đỏ) - Iron Mounted Fire Proof Collars (Red)

Mã số Code	Kích cỡ Size	A	B	C	D	Đơn giá Unit Price (VND/cái)
FPV/VL110	110	198	110.6	2.5	80	125.000
FPV/VL160	160	258	161	2.5	90	220.000

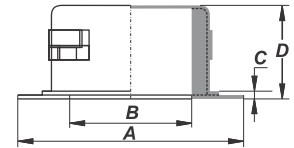
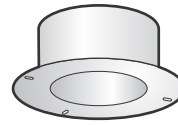
Keo dán PVC - PVC Cement

Mã số Code	Kích cỡ Size	Đơn giá Unit Price (VND/cái)
FPV/K1	250	39.000
FPV/K2	500	76.800
FPV/K3	1000	153.300
FPV/K4	15	3.600
FPV/K5	30	5.500
FPV/K6	50	8.500

