

Ống HDPE có những đặc tính quý báu và ưu việt hơn hẳn các ống nhựa khác.

- Ống nhựa HDPE rất bền, chịu được rất tốt với những chất lỏng và dung dịch thường gặp trên đường dẫn và đất thoát nước. Nó không bị rỉ, không bị tác dụng bởi các dung dịch muối, axit và kiềm, kể cả nước mưa axit cũng không ảnh hưởng tới loại ống này.

- Sự chịu đựng đối với ánh sáng mặt trời và nhiệt độ của ống HDPE rất tốt, nó không bị lão hóa về cơ lý hóa khi ống HDPE bị để lâu ngày dưới tia cực tím của mặt trời.

- Ống HDPE có đặc tính chịu uốn lệch rất tốt và có sức chịu biến dạng cao.



Ống nước HDPE và phụ kiện

HDPE Pipes & Fitting

HDPE Pipes & Fittings

HDPE - PE80 HDPE - PE100

Ống HDPE (sọc xanh)
Tiêu chuẩn 4427:2007 (E); TCVN 7305: 2008;
QCVN16:2017/BXD
Có đường kính từ Ø16mm - Ø500mm với
nguyên liệu chính PE80 và PE100 cung cấp cho
các công trình sử dụng làm hệ thống cấp nước.



Nối góc
Equal Elbow



Nối góc ren trong
Female Elbow



Nối góc ren ngoài
Male Elbow



Tê đều
Equal Tee



Tê ren trong
Female Tee



Tê ren ngoài
Male Tee



Tê chuyển bậc
Reducing Tee



Nối thẳng
Equal Coupling



Nối thẳng chuyển bậc
Reducing Coupling



Đầu nối ren trong
Female Adaptor



Đầu nối ren ngoài
Male Adaptor



Đầu bịt
End Cap

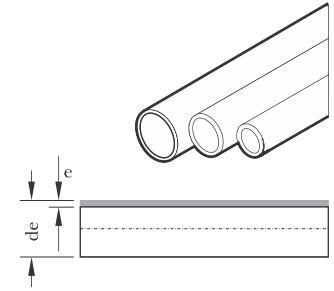

Đai khởi thủy
Tapping Saddle

Ống nước HDPE PE80 (Độ dài: 6m)
 HDPE PE80 Pipe (Length: 6m)

Ống nước HDPE PN6 - HDPE PN6 Pipes

Mã số Code	de	e
PD/16PN6	16	0.8
PD/20PN6	20	1.0
PD/25PN6	25	1.2
PD/32PN6	32	1.6
PD/40PN6	40	2.0
PD/50PN6	50	2.4
PD/63PN6	63	3.0
PD/75PN6	75	3.6
PD/90PN6	90	4.3
PD/110PN6	110	5.3
PD/125PN6	125	6.0
PD/140PN6	140	6.7
PD/160PN6	160	7.7

Mã số Code	de	e
PD/180PN6	180	8.6
PD/200PN6	200	9.6
PD/225PN6	225	10.8
PD/250PN6	250	11.9
PD/280PN6	280	13.4
PD/315PN6	315	15.0
PD/355PN6	355	16.9
PD/400PN6	400	19.1
PD/450PN6	450	21.5
PD/500PN6	500	23.9
PD/630PN6	630	30.0
PD/800PN6	800	38.1

Ống nước HDPE PN8 - HDPE PN8 Pipes

Mã số Code	de	e
PD/16PN8	16	1.0
PD/20PN8	20	1.2
PD/25PN8	25	1.5
PD/32PN8	32	2.0
PD/40PN8	40	2.4
PD/50PN8	50	3.0
PD/63PN8	63	3.8
PD/75PN8	75	4.5
PD/90PN8	90	5.4
PD/110PN8	110	6.6
PD/125PN8	125	7.4
PD/140PN8	140	8.3
PD/160PN8	160	9.5

Mã số Code	de	e
PD/180PN8	180	10.7
PD/200PN8	200	11.9
PD/225PN8	225	13.4
PD/250PN8	250	14.8
PD/280PN8	280	16.6
PD/315PN8	315	18.7
PD/355PN8	355	21.1
PD/400PN8	400	23.7
PD/450PN8	450	26.7
PD/500PN8	500	29.7
PD/630PN8	630	37.4
PD/800PN8	800	47.4

Ống nước HDPE PN10 - HDPE PN10 Pipes

Mã số Code	de	e
PD/16PN10	16	1.2
PD/20PN10	20	1.5
PD/25PN10	25	2.0
PD/32PN10	32	2.4
PD/40PN10	40	3.0
PD/50PN10	50	3.7
PD/63PN10	63	4.7
PD/75PN10	75	5.6
PD/90PN10	90	6.7
PD/110PN10	110	8.1
PD/125PN10	125	9.2
PD/140PN10	140	10.3
PD/160PN10	160	11.8

Mã số Code	de	e
PD/180PN10	180	13.3
PD/200PN10	200	14.7
PD/225PN10	225	16.6
PD/250PN10	250	18.4
PD/280PN10	280	20.6
PD/315PN10	315	23.2
PD/355PN10	355	26.1
PD/400PN10	400	29.4
PD/450PN10	450	33.1
PD/500PN10	500	36.8
PD/630PN10	630	46.3
PD/800PN10	800	48.8

Ống nước HDPE PN12.5 - HDPE PN12.5 Pipes

Mã số Code	de	e
PD/16PN12.5	16	1.5
PD/20PN12.5	20	2.0
PD/25PN12.5	25	2.3
PD/32PN12.5	32	3.0
PD/40PN12.5	40	3.7
PD/50PN12.5	50	4.6
PD/63PN12.5	63	5.8
PD/75PN12.5	75	6.8
PD/90PN12.5	90	8.2
PD/110PN12.5	110	10.0
PD/125PN12.5	125	11.4
PD/140PN12.5	140	12.7
PD/160PN12.5	160	14.6

Mã số Code	de	e
PD/180PN12.5	180	16.4
PD/200PN12.5	200	18.2
PD/225PN12.5	225	20.5
PD/250PN12.5	250	22.7
PD/280PN12.5	280	25.4
PD/315PN12.5	315	28.6
PD/355PN12.5	355	32.2
PD/400PN12.5	400	36.3
PD/450PN12.5	450	40.9
PD/500PN12.5	500	45.4
PD/630PN12.5	630	57.2
PD/800PN12.5	800	72.6

Ống nước HDPE PN16 - HDPE PN16 Pipes

Mã số Code	de	e
PD/16PN16	16	2.0
PD/20PN16	20	2.3
PD/25PN16	25	3.0
PD/32PN16	32	3.6
PD/40PN16	40	4.5
PD/50PN16	50	5.6
PD/63PN16	63	7.1
PD/75PN16	75	8.4
PD/90PN16	90	10.1
PD/110PN16	110	12.3
PD/125PN16	125	14.0
PD/140PN16	140	15.7

Mã số Code	de	e
PD/160PN16	160	17.9
PD/180PN16	180	20.1
PD/200PN16	200	22.4
PD/225PN16	225	25.2
PD/250PN16	250	27.9
PD/280PN16	280	31.3
PD/315PN16	315	35.2
PD/355PN16	355	39.7
PD/400PN16	400	44.7
PD/450PN16	450	50.3
PD/500PN16	500	55.8

Ống nước HDPE PE100

HDPE PE100 Pipe

Ống nước HDPE PN6 - HDPE PN6 Pipes

Mã số Code	de	e
PF/20PN6	20	0.8
PF/25PN6	25	1.0
PF/32PN6	32	1.3
PF/40PN6	40	1.6
PF/50PN6	50	2.0
PF/63PN6	63	2.5
PF/75PN6	75	2.9
PF/90PN6	90	3.5
PF/110PN6	110	4.2
PF/125PN6	125	4.8
PF/140PN6	140	5.4
PF/160PN6	160	6.2
PF/180PN6	180	6.9

Mã số Code	de	e
PF/200PN6	200	7.7
PF/225PN6	225	8.6
PF/250PN6	250	9.6
PF/280PN6	280	10.7
PF/315PN6	315	12.1
PF/355PN6	355	13.6
PF/400PN6	400	15.3
PF/450PN6	450	17.2
PF/500PN6	500	19.1
PF/560PN6	560	21.4
PF/630PN6	630	24.1
PF/800PN6	800	30.6

Ống nước HDPE PN8 - HDPE PN8 Pipes

Mã số Code	de	e
PF/20PN8	20	1.0
PF/25PN8	25	1.2
PF/32PN8	32	1.6
PF/40PN8	40	2.0
PF/50PN8	50	2.4
PF/63PN8	63	3.0
PF/75PN8	75	3.6
PF/90PN8	90	4.3
PF/110PN8	110	5.3
PF/125PN8	125	6.0
PF/140PN8	140	6.7
PF/160PN8	160	7.7
PF/180PN8	180	8.6

Mã số Code	de	e
PF/200PN8	200	9.60
PF/225PN8	225	10.8
PF/250PN8	250	11.9
PF/280PN8	280	13.4
PF/315PN8	315	15.0
PF/355PN8	355	16.9
PF/400PN8	400	19.1
PF/450PN8	450	21.5
PF/500PN8	500	23.9
PF/560PN8	560	26.7
PF/630PN8	630	30.0
PF/800PN8	800	38.1

Ống nước HDPE PN10 - HDPE PN10 Pipes

Mã số Code	de	e
PF/20PN10	20	1.2
PF/25PN10	25	1.5
PF/32PN10	32	2.0
PF/40PN10	40	2.4
PF/50PN10	50	3.0
PF/63PN10	63	3.8
PF/75PN10	75	4.5
PF/90PN10	90	5.4
PF/110PN10	110	6.6
PF/125PN10	125	7.4
PF/140PN10	140	8.3
PF/160PN10	160	9.5
PF/180PN10	180	10.7

Mã số Code	de	e
PF/200PN10	200	11.9
PF/225PN10	225	13.4
PF/250PN10	250	14.8
PF/280PN10	280	16.6
PF/315PN10	315	18.7
PF/355PN10	355	21.1
PF/400PN10	400	23.7
PF/450PN10	450	26.7
PF/500PN10	500	29.7
PF/560PN10	560	33.2
PF/630PN10	630	37.4
PF/800PN10	800	48.8

Ống nước HDPE PN12.5 - HDPE PN12.5 Pipes

Mã số Code	de	e
PF/20PN12.5	20	1.5
PF/25PN12.5	25	2.0
PF/32PN12.5	32	2.4
PF/40PN12.5	40	3.0
PF/50PN12.5	50	3.7
PF/63PN12.5	63	4.7
PF/75PN12.5	75	5.6
PF/90PN12.5	90	6.7
PF/110PN12.5	110	8.1
PF/125PN12.5	125	9.2
PF/140PN12.5	140	10.3
PF/160PN12.5	160	11.8
PF/180PN12.5	180	13.3

Mã số Code	de	e
PF/200PN12.5	200	14.7
PF/225PN12.5	225	16.6
PF/250PN12.5	250	18.4
PF/280PN12.5	280	20.6
PF/315PN12.5	315	23.2
PF/355PN12.5	355	26.1
PF/400PN12.5	400	29.4
PF/450PN12.5	450	33.1
PF/500PN12.5	500	36.8
PF/560PN12.5	560	41.2
PF/630PN12.5	630	46.3
PF/800PN12.5	800	48.8

Ống nước HDPE PN16 - HDPE PN16 Pipes

Mã số Code	de	e
PF/20PN16	20	2.0
PF/25PN16	25	2.3
PF/32PN16	32	3.0
PF/40PN16	40	3.7
PF/50PN16	50	4.6
PF/63PN16	63	5.8
PF/75PN16	75	6.8
PF/90PN16	90	8.2
PF/110PN16	110	10.0
PF/125PN16	125	11.4
PF/140PN16	140	12.7
PF/160PN16	160	14.6
PF/180PN16	180	16.4

Mã số Code	de	e
PF/200PN16	200	18.2
PF/225PN16	225	20.5
PF/250PN16	250	22.7
PF/280PN16	280	25.4
PF/315PN16	315	28.6
PF/355PN16	355	32.2
PF/400PN16	400	36.3
PF/450PN16	450	40.9
PF/500PN16	500	45.4
PF/560PN16	560	50.8
PF/630PN16	630	57.2
PF/800PN16	800	72.6

Ống nước HDPE PN20 - HDPE PN20 Pipes

Mã số Code	de	e
PF/16PN20	16	2.0
PF/20PN20	20	2.3
PF/25PN20	25	3.0
PF/32PN20	32	3.6
PF/40PN20	40	4.5
PF/50PN20	50	5.6
PF/63PN20	63	7.1
PF/75PN20	75	8.4
PF/90PN20	90	10.1
PF/110PN20	110	12.3
PF/125PN20	125	14.0
PF/140PN20	140	15.7

Mã số Code	de	e
PF/160PN20	160	17.9
PF/180PN20	180	20.1
PF/200PN20	200	22.4
PF/225PN20	225	25.2
PF/250PN20	250	27.9
PF/280PN20	280	31.3
PF/315PN20	315	35.2
PF/355PN20	355	39.7
PF/400PN20	400	44.7
PF/450PN20	450	50.3
PF/500PN20	500	55.8

Phụ kiện ống nước HDPE
Nối góc - Equal Elbow

Mã số Code	D	L
FPD/EE20	20	68
FPD/EE25	25	75
FPD/EE32	32	80
FPD/EE40	40	95
FPD/EE50	50	120
FPD/EE63	63	135
FPD/EE75	75	-
FPD/EE90	90	-
FPD/EE110	110	-

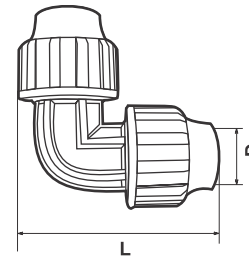
Nối góc ren trong - Female Elbow

Mã số Code	D	G	L	L1
FPD/FE20 x 1/2	20	1/2"	68	43
FPD/FE25 x 1/2	25	1/2"	-	-
FPD/FE25 x 3/4	25	3/4"	75	49
FPD/FE32 x 3/4	32	3/4"	-	-
FPD/FE32 x 1	32	1"	82	60
FPD/FE40 x 1 1/4	40	1 1/4"	100	65
FPD/FE50 x 1 1/2	50	1 1/2"	115	75
FPD/FE63 x 2	63	2"	135	85
FPD/FE75 x 2 1/2	75	2 1/2"	-	-
FPD/FE90 x 3	90	3"	-	-

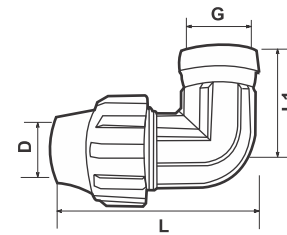
Nối góc ren ngoài - Male Elbow

Mã số Code	D	G	L	L1
FPD/ME20 x 1/2	20	1/2"	68	43
FPD/ME20 x 3/4	20	3/4"	-	-
FPD/ME25 x 1/2	25	1/2"	-	-
FPD/ME25 x 3/4	25	3/4"	75	50
FPD/ME25 x 1	25	1"	-	-
FPD/ME32 x 1/2	32	1/2"	-	-
FPD/ME32 x 3/4	32	3/4"	-	-
FPD/ME32 x 1	32	1"	80	60
FPD/ME40 x 1 1/4	40	1 1/4"	98	65
FPD/ME40 x 1 1/2	40	1 1/2"	-	-
FPD/ME50 x 1	50	1"	-	-
FPD/ME50 x 1 1/4	50	1 1/4"	-	-
FPD/ME50 x 1 1/2	50	1 1/2"	115	85
FPD/ME63 x 1 1/4	63	1 1/4"	-	-
FPD/ME63 x 1 1/2	63	1 1/2"	-	-
FPD/ME63 x 2	63	2"	135	85
FPD/ME90 x 3	90	3"	-	-

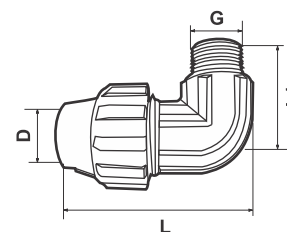
Chú ý:

Áp suất làm việc ở 20°C: 10bar - Working pressure 20°C: 10bar

Tê đều - Equal Tee

Mã số Code	D	L	L1
FPD/ET20	20	130	65
FPD/ET25	25	140	75
FPD/ET32	32	160	80
FPD/ET40	40	190	95
FPD/ET50	50	240	120
FPD/ET63	63	270	135
FPD/ET75	75	-	-
FPD/ET90	90	-	-
FPD/ET110	110	-	-

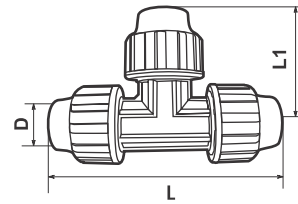
Tê ren trong - Female Tee

Mã số Code	D	G	L	L1
FPD/FT20 x 1/2	20	1/2"	135	45
FPD/FT25 x 1/2	25	1/2"	-	-
FPD/FT25 x 3/4	25	3/4"	150	50
FPD/FT32 x 3/4	32	3/4"	-	-
FPD/FT32 x 1	32	1"	162	60
FPD/FT40 x 1 1/4	40	1 1/4"	192	65
FPD/FT50 x 1 1/4	50	1 1/4"	-	-
FPD/FT50 x 1 1/2	50	1 1/2"	232	75
FPD/FT63 x 1 1/2	63	1 1/2"	-	-
FPD/FT63 x 2	63	2"	270	85
FPD/FT75 x 2 1/2	75	2 1/2"	-	-
FPD/FT90 x 2 1/2	90	2 1/2"	-	-
FPD/FT90 x 3	90	3"	-	-
FPD/FT110x4	110	4"	-	-

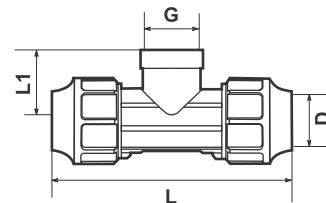
Tê ren ngoài - Male Tee

Mã số Code	D	G	L	L1
FPD/MT20 x 1/2	20	1/2"	130	48
FPD/MT20 x 3/4	20	3/4"	-	-
FPD/MT25 x 1/2	25	1/2"	-	-
FPD/MT25 x 3/4	25	3/4"	150	50
FPD/MT25 x 1	25	1"	-	-
FPD/MT32 x 1/2	32	1/2"	-	-
FPD/MT32 x 3/4	32	3/4"	-	-
FPD/MT32 x 1	32	1"	162	62
FPD/MT32 x 1 1/4	32	1 1/4"	-	-
FPD/MT40 x 1 1/4	40	1 1/4"	192	68
FPD/MT50 x 1 1/2	50	1 1/2"	232	80
FPD/MT50 x 2	50	2"	-	-
FPD/MT63 x 2	63	2"	270	85
FPD/MT75 x 2 1/2	75	2 1/2"	-	-
FPD/MT90 x 3	90	3"	-	-

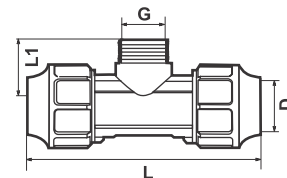
Chú ý:

Áp suất làm việc ở 20°C: 10bar - Working pressure 20°C: 10bar

Tê chuyển bậc - Reducing Tee

Mã số Code	D	D1	L	L1
FPD/RT25 x 20	25	20	150	70
FPD/RT32 x 25	32	25	160	85
FPD/RT40 x 25	40	25	-	-
FPD/RT40 x 32	40	32	192	90
FPD/RT50 x 25	50	25	-	-
FPD/RT50 x 32	50	32	-	-
FPD/RT50 x 40	50	40	230	110
FPD/RT63 x 20	63	20	-	-
FPD/RT63 x 25	63	25	-	-
FPD/RT63 x 32	63	32	-	-
FPD/RT63 x 40	63	40	-	-
FPD/RT63 x 50	63	50	270	125
FPD/RT75 x 63	75	63	-	-

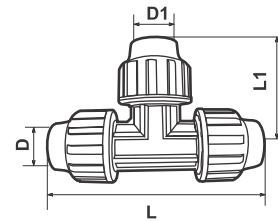
Nối thẳng - Equal Coupling

Mã số Code	D	L
FPD/EC20	20	108
FPD/EC25	25	120
FPD/EC32	32	125
FPD/EC40	40	150
FPD/EC50	50	180
FPD/EC63	63	215
FPD/EC75	75	-
FPD/EC90	90	-
FPD/EC110	110	-

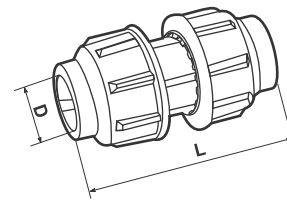
Nối thẳng chuyển bậc - Reducing Coupling

Mã số Code	D	D1	L
FPD/RC25 x 20	25	20	110
FPD/RC32 x 20	32	20	116
FPD/RC32 x 25	32	25	120
FPD/RC40 x 20	40	20	-
FPD/RC40 x 25	40	25	135
FPD/RC40 x 32	40	32	136
FPD/RC50 x 25	50	25	-
FPD/RC50 x 32	50	32	148
FPD/RC50 x 40	50	40	165
FPD/RC63 x 20	63	20	-
FPD/RC63 x 25	63	25	-
FPD/RC63 x 32	63	32	-
FPD/RC63 x 40	63	40	188
FPD/RC63 x 50	63	50	200
FPD/RC75 x 50	75	50	-
FPD/RC75 x 63	75	63	-
FPD/RC90 x 63	90	63	-
FPD/RC90 x 75	90	75	-
FPD/RC110 x 90	110	90	-

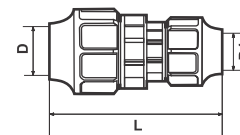
Chú ý:

Áp suất làm việc ở 20°C: 10bar - Working pressure 20°C: 10bar

Đầu nối ren trong - Female Adaptor

Mã số Code	D	G	L
FPD/FA20 x 1/2	20	1/2"	75
FPD/FA20 x 3/4	20	3/4"	-
FPD/FA25 x 1/2	25	1/2"	-
FPD/FA25 x 3/4	25	3/4"	82
FPD/FA32 x 3/4	32	3/4"	-
FPD/FA32 x 1	32	1"	90
FPD/FA40 x 1 1/4	40	1 1/4"	105
FPD/FA50 x 1 1/2	50	1 1/2"	115
FPD/FA63 x 2	63	2"	140
FPD/FA75 x 2 1/2	75	2 1/2"	-
FPD/FA90 x 3	90	3"	-
FPD/FA110 x 4	110	4"	-

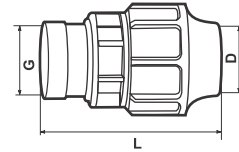
Đầu nối ren ngoài - Male Adaptor

Mã số Code	D	G	L
FPD/MA20 x 1/2	20	1/2"	75
FPD/MA20 x 3/4	20	3/4"	-
FPD/MA20 x 1	20	1"	-
FPD/MA25 x 1/2	25	1/2"	-
FPD/MA25 x 3/4	25	3/4"	82
FPD/MA25 x 1	25	1"	-
FPD/MA32 x 1/2	32	1/2"	-
FPD/MA32 x 3/4	32	3/4"	-
FPD/MA32 x 1	32	1"	90
FPD/MA32 x 1 1/4	32	1 1/4"	-
FPD/MA32 x 1 1/2	32	1 1/2"	-
FPD/MA40 x 1	40	1"	-
FPD/MA40 x 1 1/4	40	1 1/4"	102
FPD/MA40 x 1 1/2	40	1 1/2"	-
FPD/MA40 x 2	40	2"	-
FPD/MA50 x 3/4	50	3/4"	-
FPD/MA50 x 1	50	1"	-
FPD/MA50 x 1 1/4	50	1 1/4"	-
FPD/MA50 x 1 1/2	50	1 1/2"	118
FPD/MA50 x 2	50	2"	-
FPD/MA63 x 3/4	63	3/4"	-
FPD/MA63 x 1	63	1"	-
FPD/MA63 x 1 1/2	63	1 1/2"	-
FPD/MA63 x 2	63	2"	140
FPD/MA63 x 2 1/2	63	2 1/2"	-
FPD/MA75 x 2	75	2"	-
FPD/MA75 x 2 1/2	75	2 1/2"	-
FPD/MA75 x 3	75	3"	-
FPD/MA90 x 1 1/2	90	1 1/2"	-
FPD/MA90 x 2	90	2"	-
FPD/MA90 x 2 1/2	90	2 1/2"	-
FPD/MA90 x 3	90	3"	-
FPD/MA110 x 3	110	3"	-
FPD/MA110 x 4	110	4"	-

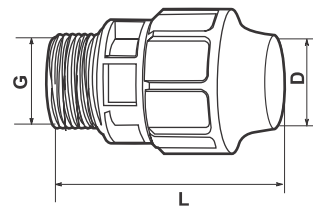

Chú ý:

Áp suất làm việc ở 20°C: 10bar - Working pressure 20°C: 10bar

Đầu bịt - End Cap

Mã số Code	D	L
FPD/CE20	20	54
FPD/CE25	25	60
FPD/CE32	32	62
FPD/CE40	40	75
FPD/CE50	50	90
FPD/CE63	63	108
FPD/CE75	75	-
FPD/CE90	90	-
FPD/CE110	110	-

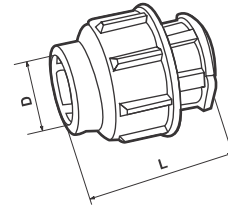

Bích nhựa - Plastic Flange

Mã số Code	Kích cỡ Size
FPD/PF40	40
FPD/PF50	50
FPD/PF63	63
FPD/PF75	75
FPD/PF90	90
FPD/PF110	110

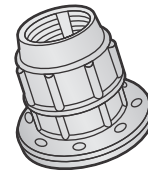

Van ren ngoài - Female Valve

Mã số Code	Kích cỡ Size
FPD/MV20	20
FPD/MV25	25
FPD/MV32	32
FPD/MV40	40
FPD/MV50	50
FPD/MV63	63

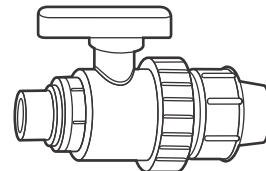

Van ren trong - Male Valve

Mã số Code	Kích cỡ Size
FPD/FV20	20
FPD/FV25	25
FPD/FV32	32
FPD/FV40	40
FPD/FV50	50
FPD/FV63	63

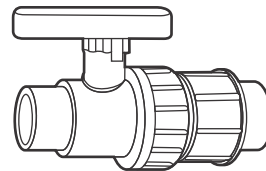

Chú ý:

Áp suất làm việc ở 20°C: 10bar - Working pressure 20°C: 10bar

Van - Valve

Mã số Code	Kích cỡ Size
FPD/V20	20
FPD/V25	25
FPD/V32	32
FPD/V40	40
FPD/V50	50
FPD/V63	63

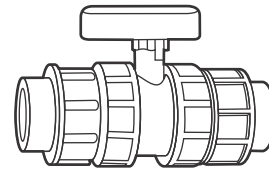

Nối thẳng ren ngoài - Adaptor Bushes Equal

Mã số Code	Kích cỡ Size
FPD/AR3/4 x 1/2	3/4 x 1/2"
FPD/AR1 x 1/2	1 x 1/2"
FPD/AR1 x 3/4	1 x 3/4"
FPD/AR1 1/2 x 1	1 1/2 x 1"
FPD/AR2 x 1 1/2	2 x 1 1/2"
FPD/AR3 x 2	3 x 2"

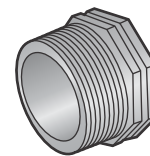

Nối thẳng 2 đầu ren ngoài - Hexagon Nipples

Mã số Code	Kích cỡ Size
FPD/HN3/4 x 1/2	3/4 x 1/2"
FPD/HN1 x 1/2	1 x 1/2"
FPD/HN1 x 3/4	1 x 3/4"
FPD/HN1 1/2 x 1/2	1 1/2 x 1/2"
FPD/HN1 1/2 x 3/4	1 1/2 x 3/4"
FPD/HN1 1/2 x 1	1 1/2 x 1"
FPD/HN2 x 3/4	2 x 3/4"
FPD/HN2 x 1	2 x 1"
FPD/HN2 x 1 1/2	2 x 1 1/2"
FPD/HN3 x 2	3 x 2"
FPD/HN3 x 2 1/2	3 x 2 1/2"

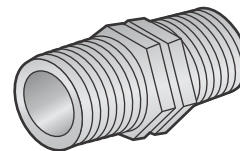

Bích thép (mạ kẽm) - Slimflange Backing Rings (Galvanised mild steel)

Mã số Code	Kích cỡ Size	d
FPD/SB40	40	48
FPD/SB50	50	58
FPD/SB63	63	71
FPD/SB75	75	83
FPD/SB90	90	98
FPD/SB110	110	108
FPD/SB180	180	188
FPD/SB200	200	208
FPD/SB225	225	235
FPD/SB250	250	260
FPD/SB280	280	290
FPD/SB315	315	325
FPD/SB355	355	365
FPD/SB400	400	410
FPD/SB450	450	460
FPD/SB500	500	512

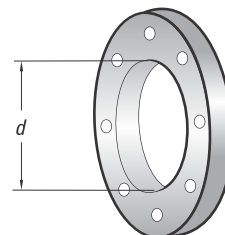

Đai khởi thủy - Tapping Saddle

Mã số Code	Kích cỡ Size
FPD/TS25 x 1/2	25 x 1/2"
FPD/TS25 x 3/4	25 x 3/4"
FPD/TS32 x 1/2	32 x 1/2"
FPD/TS32 x 3/4	32 x 3/4"
FPD/TS32 x 1	32 x 1"
FPD/TS40 x 1/2	40 x 1/2"
FPD/TS40 x 3/4	40 x 3/4"
FPD/TS40 x 1	40 x 1"
FPD/TS50 x 1/2	50 x 1/2"
FPD/TS50 x 3/4	50 x 3/4"
FPD/TS50 x 1	50 x 1"
FPD/TS63 x 1/2	63 x 1/2"
FPD/TS63 x 3/4	63 x 3/4"
FPD/TS63 x 1	63 x 1"
FPD/TS63 x 1 1/4	63 x 1 1/4"
FPD/TS75 x 1/2	75 x 1/2"
FPD/TS75 x 3/4	75 x 3/4"
FPD/TS75 x 1	75 x 1"
FPD/TS75 x 1 1/4	75 x 1 1/4"
FPD/TS75 x 1 1/2	75 x 1 1/2"
FPD/TS75 x 2	75 x 2"
FPD/TS90 x 1/2	90 x 1/2"
FPD/TS90 x 3/4	90 x 3/4"
FPD/TS90 x 1	90 x 1"
FPD/TS90 x 1 1/4	90 x 1 1/4"
FPD/TS90 x 1 1/2	90 x 1 1/2"
FPD/TS90 x 2	90 x 2"
FPD/TS110 x 1/2	110 x 1/2"
FPD/TS110 x 3/4	110 x 3/4"
FPD/TS110 x 1	110 x 1"
FPD/TS110 x 1 1/4	110 x 1 1/4"
FPD/TS110 x 1 1/2	110 x 1 1/2"
FPD/TS110 x 2	110 x 2"
FPD/TS110 x 3	110 x 3"
FPD/TS125 x 1	125 x 1"
FPD/TS125 x 1 1/4	125 x 1 1/4"
FPD/TS125 x 1 1/2	125 x 1 1/2"
FPD/TS125 x 2	125 x 2"
FPD/TS125 x 2 1/2	125 x 2 1/2"
FPD/TS140 x 2	140 x 2"
FPD/TS140 x 2 1/2	140 x 2 1/2"
FPD/TS160 x 1	160 x 1"
FPD/TS160 x 1 1/4	160 x 1 1/4"
FPD/TS160 x 1 1/2	160 x 1 1/2"
FPD/TS160 x 2	160 x 2"
FPD/TS160 x 2 1/2	160 x 2 1/2"
FPD/TS180 x 2	180 x 2"
FPD/TS180 x 2 1/2	180 x 2 1/2"
FPD/TS200 x 3/4	200 x 3/4"
FPD/TS200 x 1	200 x 1"
FPD/TS200 x 1 1/4	200 x 1 1/4"
FPD/TS200 x 1 1/2	200 x 1 1/2"
FPD/TS200 x 2	200 x 2"
FPD/TS200 x 2 1/2	200 x 2 1/2"
FPD/TS225 x 2	225 x 2"
FPD/TS225 x 2 1/2	225 x 2 1/2"
FPD/TS250 x 3/4	250 x 3/4"
FPD/TS250 x 1	250 x 1"
FPD/TS250 x 2	250 x 2"
FPD/TS250 x 2 1/2	250 x 2 1/2"
FPD/TS250 x 3	250 x 3"
FPD/TS250 x 4	250 x 4"
FPD/TS280 x 2	280 x 2"
FPD/TS280 x 2 1/2	280 x 2 1/2"

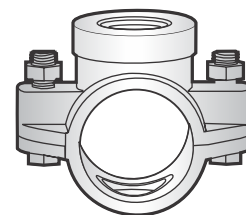

Phụ kiện hàn - Fusion Fittings

Nối góc 22.5° - Elbow 22.5°

Mã số Code	Kích cỡ Size
FPD/EC110	110
FPD/EC160	160
FPD/EC200	200
FPD/EC250	250
FPD/EC315	315
FPD/EC400	400

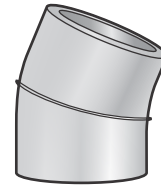

Nối góc 45° hàn - Elbow 45°

Mã số Code	ØD	L
FPD/EB90	90	150
FPD/EB110	110	150
FPD/EB125	125	150
FPD/EB140	140	150
FPD/EB160	160	150
FPD/EB180	180	200
FPD/EB200	200	200
FPD/EB225	225	200
FPD/EB250	250	200
FPD/EB280	280	200
FPD/EB315	315	300
FPD/EB355	355	300
FPD/EB400	400	300
FPD/EB450	450	300
FPD/EB500	500	300
FPD/EB560	560	-
FPD/EB630	630	-

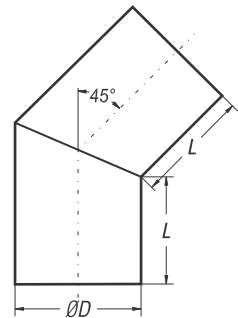
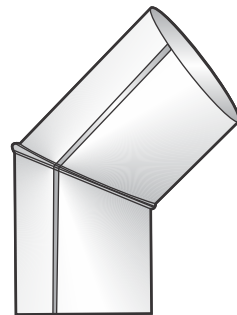

Nối góc 90° hàn - Elbow 90°

Mã số Code	ØD	L	A
FPD/EG90	90	150	150
FPD/EG110	110	150	150
FPD/EG125	125	150	150
FPD/EG140	140	150	150
FPD/EG160	160	150	150
FPD/EG180	180	200	150
FPD/EG200	200	200	150
FPD/EG225	225	200	150
FPD/EG250	250	200	150
FPD/EG280	280	200	150
FPD/EG315	315	300	200
FPD/EG355	355	300	200
FPD/EG400	400	300	200
FPD/EG450	450	300	200
FPD/EG500	500	300	200
FPD/EG560	560	-	-
FPD/EG630	630	-	-

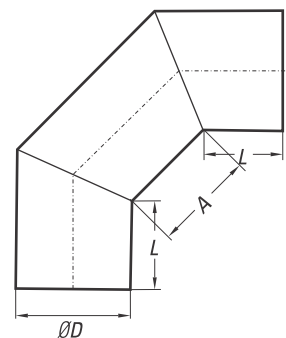
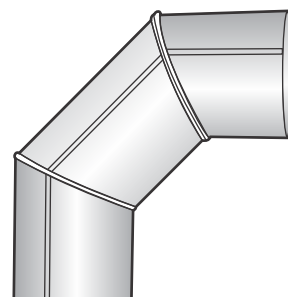

Y 45° hàn - Y 45°

Mã số Code	ØD	L	A
FPD/YT90	90	150	410
FPD/YT110	110	150	410
FPD/YT125	125	150	425
FPD/YT140	140	150	440
FPD/YT160	160	150	460
FPD/YT180	180	200	580
FPD/YT200	200	200	600
FPD/YT225	225	200	625
FPD/YT250	250	200	650
FPD/YT280	280	200	680
FPD/YT315	315	300	915
FPD/YT355	355	300	955
FPD/YT400	400	300	1000
FPD/YT450	450	300	1050
FPD/YT500	500	300	1100
FPD/YT560	560	-	-
FPD/YT630	630	-	-

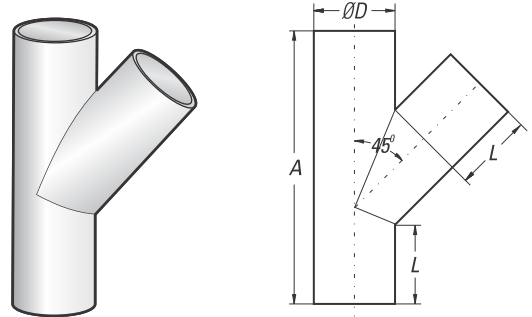

Y 60° hàn - Y 60°

Mã số Code	ØD	L	A
FPD/YE90	90	150	410
FPD/YE110	110	150	410
FPD/YE125	125	150	425
FPD/YE140	140	150	440
FPD/YE160	160	150	460
FPD/YE180	180	200	580
FPD/YE200	200	200	600
FPD/YE225	225	200	625
FPD/YE250	250	200	650
FPD/YE280	280	200	680
FPD/YE315	315	300	915
FPD/YE355	355	300	955
FPD/YE400	400	300	1000
FPD/YE450	450	300	1050
FPD/YE500	500	300	1100
FPD/YE560	560	-	-
FPD/YE630	630	-	-

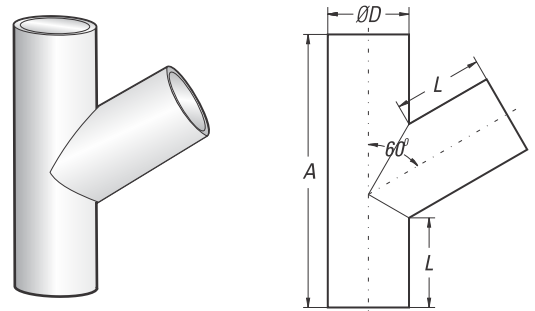

Y thu 45° - Reducing Y Pieces 45°

Mã số Code	Kích cỡ Size
FPD/YT7550	75 x 50
FPD/YT7563	75 x 63
FPD/YT9050	90 x 50
FPD/YT9063	90 x 63
FPD/YT9075	90 x 75
FPD/YT11063	110 x 63
FPD/YT11090	110 x 90
FPD/YT16063	160 x 63
FPD/YT16090	160 x 90
FPD/YT160110	160 x 110

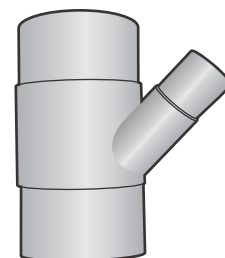

Đầu nối chuyển bậc hàn - Coupling Reduced

Mã số Code	D1 - D2 - D3	L	L1	L2	L3
FPD/CR907563	63 x 75 x 90	150	50	50	50
FPD/CR12511090	90 x 110 x 125	150	50	50	50
FPD/CR160140125	125 x 140 x 160	210	70	70	70
FPD/CR200180160	160 x 180 x 200	210	70	70	70

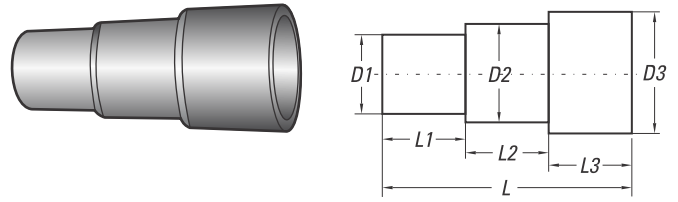

Đầu nối bằng bích - Flange Adaptor

Mã số Code	ØD	ØD1	L	A
FPD/AF63x90	63	90	130	20
FPD/AF75x110	75	110	130	20
FPD/AF90x125	90	125	130	20
FPD/AF110x140	110	140	255	20
FPD/AF125x160	125	160	200	38
FPD/AF140x180	140	180	200	40
FPD/AF160x200	160	200	200	20
FPD/AF180x218	180	218	255	25
FPD/AF200x250	200	250	255	27
FPD/AF225x268	225	268	255	27
FPD/AF250x315	250	315	255	30
FPD/AF280x320	280	320	255	30
FPD/AF315x370	315	370	255	33
FPD/AF355x385	355	385	340	36
FPD/AF400x450	400	450	340	36
FPD/AF450x500	450	500	350	38
FPD/AF500x555	500	555	350	40

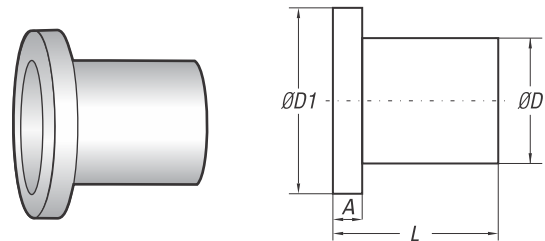

Tê 90° hàn - Tees 90°

Mã số Code	ØD	L	A
FPD/TD110	110	150	410
FPD/TD125	125	150	425
FPD/TD140	140	150	440
FPD/TD160	160	150	460
FPD/TD180	180	200	580
FPD/TD200	200	200	600
FPD/TD225	225	200	625
FPD/TD250	250	200	650
FPD/TD280	280	200	680
FPD/TD315	315	300	915
FPD/TD355	355	300	955
FPD/TD400	400	300	1000
FPD/TD450	450	300	1050
FPD/TD500	500	300	1100
FPD/TD560	560	-	-
FPD/TD630	630	-	-

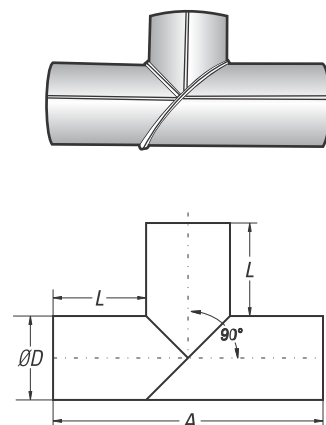

Thập đều hàn - Cross

Mã số Code	ØD	L	A
FPD/CS75	75		
FPD/CS90	90	150	390
FPD/CS110	110	150	410
FPD/CS125	125	150	425
FPD/CS140	140	150	440
FPD/CS160	160	150	460
FPD/CS180	180	200	580
FPD/CS200	200	200	600
FPD/CS225	225	200	625
FPD/CS250	250	200	650
FPD/CS280	280	200	680
FPD/CS315	315	300	915
FPD/CS355	355	300	955
FPD/CS400	400	300	1000
FPD/CS450	450	300	1050
FPD/CS500	500	300	1100
FPD/CS560	560	-	-
FPD/CS630	630	-	-

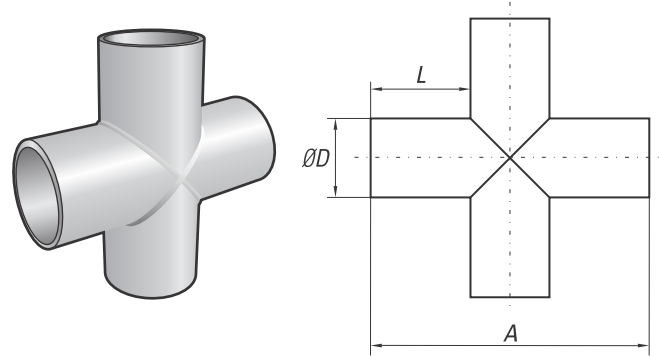

Đầu bịt - End Cap

Mã số Code	Kích cỡ Size
FPD/DB63	63
FPD/DB75	75
FPD/DB90	90
FPD/DB110	110
FPD/DB125	125
FPD/DB140	140
FPD/DB160	160
FPD/DB180	180
FPD/DB200	200
FPD/DB225	225
FPD/DB250	250
FPD/DB280	280
FPD/DB315	315
FPD/DB355	355
FPD/DB400	400
FPD/DB450	450
FPD/DB500	500
FPD/DB560	560
FPD/DB630	630

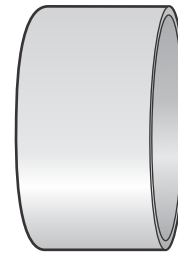

Phụ kiện hàn nối đầu - Butt Fusion Fittings

Tê thu nối hàn - Fabricated Reducing Tee Assembly

Mã số Code	Kích cỡ Size
FPDFF/TA20050	200 x 50
FPDFF/TA200110	200 x 110
FPDFF/TA200125	200 x 125
FPDFF/TA200160	200 x 160
FPDFF/TA22550	225 x 50
FPDFF/TA225125	225 x 125
FPDFF/TA225160	225 x 160
FPDFF/TA225200	225 x 200
FPDFF/TA25050	250 x 50
FPDFF/TA250160	250 x 160
FPDFF/TA250200	250 x 200
FPDFF/TA250225	250 x 225
FPDFF/TA280160	280 x 160
FPDFF/TA280200	280 x 200
FPDFF/TA31550	315 x 50
FPDFF/TA315180	315 x 180
FPDFF/TA315200	315 x 200
FPDFF/TA315225	315 x 225
FPDFF/TA315250	315 x 250
FPDFF/TA315280	315 x 280
FPDFF/TA35550	355 x 50
FPDFF/TA355180	355 x 180
FPDFF/TA355200	355 x 200
FPDFF/TA355225	355 x 225
FPDFF/TA355250	355 x 250
FPDFF/TA355280	355 x 280
FPDFF/TA355315	355 x 315
FPDFF/TA40050	400 x 50
FPDFF/TA400200	400 x 200
FPDFF/TA400225	400 x 225
FPDFF/TA400250	400 x 250
FPDFF/TA400280	400 x 280
FPDFF/TA400315	400 x 315
FPDFF/TA400355	400 x 355
FPDFF/TA450180	450 x 180
FPDFF/TA450200	450 x 200
FPDFF/TA450225	450 x 225
FPDFF/TA450250	450 x 250
FPDFF/TA450280	450 x 280
FPDFF/TA450315	450 x 315
FPDFF/TA450355	450 x 355
FPDFF/TA450400	450 x 400
FPDFF/TA500180	500 x 180
FPDFF/TA500200	500 x 200
FPDFF/TA500225	500 x 225
FPDFF/TA500250	500 x 250
FPDFF/TA500280	500 x 280
FPDFF/TA500315	500 x 315
FPDFF/TA500355	500 x 355
FPDFF/TA500400	500 x 400
FPDFF/TA500450	500 x 450
FPDFF/TA560225	560 x 225
FPDFF/TA560280	560 x 280
FPDFF/TA560315	560 x 315
FPDFF/TA630180	630 x 180
FPDFF/TA630200	630 x 200
FPDFF/TA630225	630 x 225
FPDFF/TA630250	630 x 250
FPDFF/TA630280	630 x 280
FPDFF/TA630315	630 x 315
FPDFF/TA630355	630 x 355
FPDFF/TA630400	630 x 400
FPDFF/TA630450	630 x 450
FPDFF/TA630500	630 x 500

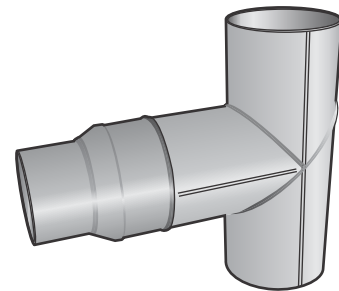

Cút thu nối đầu (côn thu) - Reducing Sockets (plain)

Mã số Code	Kích cỡ Size
FPD/RS75x50	75 x 50
FPD/RS75x63	75 x 63
FPD/RS90x50	90 x 50
FPD/RS90x63	90 x 63
FPD/RS90x75	90 x 75
FPD/RS110x50	110 x 50
FPD/RS110x63	110 x 63
FPD/RS110x75	110 x 75
FPD/RS110x90	110 x 90
FPD/RS125x50	125 x 50
FPD/RS125x63	125 x 63
FPD/RS125x75	125 x 75
FPD/RS125x90	125 x 90
FPD/RS125x110	125 x 110
FPD/RS140x63	140 x 63
FPD/RS140x75	140 x 75
FPD/RS140x90	140 x 90
FPD/RS140x110	140 x 110
FPD/RS140x125	140 x 125
FPD/RS160x63	160 x 63
FPD/RS160x75	160 x 75
FPD/RS160x90	160 x 90
FPD/RS160x110	160 x 110
FPD/RS160x125	160 x 125
FPD/RS160x140	160 x 140
FPD/RS180x90	180 x 90
FPD/RS180x110	180 x 110
FPD/RS180x125	180 x 125
FPD/RS180x140	180 x 140
FPD/RS180x160	180 x 160
FPD/RS200x63	200 x 63
FPD/RS200x75	200 x 75
FPD/RS200x90	200 x 90
FPD/RS200x110	200 x 110
FPD/RS200x125	200 x 125
FPD/RS200x160	200 x 160
FPD/RS200x180	200 x 180
FPD/RS225x90	225 x 90
FPD/RS225x110	225 x 110
FPD/RS225x125	225 x 125
FPD/RS225x160	225 x 160
FPD/RS225x200	225 x 200
FPD/RS250x90	250 x 90
FPD/RS250x110	250 x 110
FPD/RS250x125	250 x 125
FPD/RS250x160	250 x 160
FPD/RS250x200	250 x 200
FPD/RS250x225	250 x 225
FPD/RS280x110	280 x 110
FPD/RS280x200	280 x 200
FPD/RS280x225	280 x 225
FPD/RS280x250	280 x 250
FPD/RS315x90	315 x 90
FPD/RS315x110	315 x 110
FPD/RS315x125	315 x 125
FPD/RS315x160	315 x 160
FPD/RS315x200	315 x 200

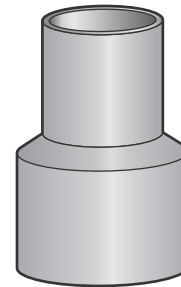

Cút thu (côn thu) - Reducing Sockets (plain)

Mã số Code	Kích cỡ Size
FPD/RS315x225	315 x 225
FPD/RS315x250	315 x 250
FPD/RS315x280	315 x 280
FPD/RS355x110	355 x 110
FPD/RS355x160	355 x 160
FPD/RS355x200	355 x 200
FPD/RS355x250	355 x 250
FPD/RS355x280	355 x 280
FPD/RS355x315	355 x 315
FPD/RS400x110	400 x 110
FPD/RS400x160	400 x 160
FPD/RS400x200	400 x 200
FPD/RS400x225	400 x 225
FPD/RS400x250	400 x 250
FPD/RS400x315	400 x 315
FPD/RS400x355	400 x 355
FPD/RS450x110	450 x 110
FPD/RS450x160	450 x 160
FPD/RS450x200	450 x 200
FPD/RS450x225	450 x 225
FPD/RS450x250	450 x 250
FPD/RS450x315	450 x 315
FPD/RS450x355	450 x 355
FPD/RS450x400	450 x 400
FPD/RS500x200	500 x 200
FPD/RS500x250	500 x 250
FPD/RS500x315	500 x 315
FPD/RS500x355	500 x 355
FPD/RS500x400	500 x 400
FPD/RS500x450	500 x 450
FPD/RS560x315	560 x 315
FPD/RS560x355	560 x 355
FPD/RS560x400	560 x 400
FPD/RS560x450	560 x 450
FPD/RS560x500	560 x 500
FPD/RS630x200	630 x 200
FPD/RS630x250	630 x 250
FPD/RS630x315	630 x 315
FPD/RS630x355	630 x 355
FPD/RS630x400	630 x 400
FPD/RS630x450	630 x 450
FPD/RS630x500	630 x 500
FPD/RS630x560	630 x 560

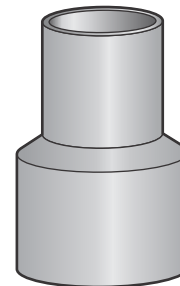

Đầu bịt - End Cap

Mã số Code	Kích cỡ Size	L	A
FPDBF/DB20	20	45	41
FPDBF/DB25	25	46	41
FPDBF/DB32	32	51	45
FPDBF/DB40	40	87	67
FPDBF/DB50	50	90	66
FPDBF/DB63	63	77	63
FPDBF/DB75	75	84	70
FPDBF/DB90	90	92	79
FPDBF/DB110	110	97	82
FPDBF/DB125	125	112	87
FPDBF/DB160	160	119	98
FPDBF/DB180	180	145	110
FPDBF/DB200	200	147	112
FPDBF/DB225	225	155	118
FPDBF/DB250	250	186	128
FPDBF/DB315	315	190	150
FPDBF/DB355	355	215	155
FPDBF/DB400	400	220	160
FPDBF/DB500	500	240	190
FPDBF/DB630	630	240	190

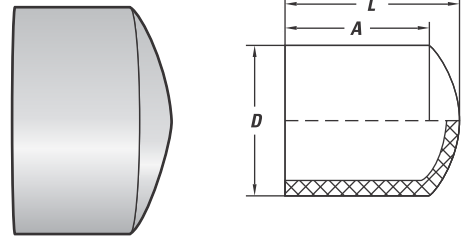

Thập đều hàn - Cross

Mã số Code	Kích cỡ Size	L	A	H
FPDBF/CS63	63	230	63	115
FPDBF/CS90	90	295	79	147
FPDBF/CS110	110	380	82	190
FPDBF/CS160	160	430	98	215
FPDBF/CS200	200	420	90	210
FPDBF/CS250	250	500	110	250
FPDBF/CS315	315	615	130	307
FPDBF/CS355	355	660	130	330

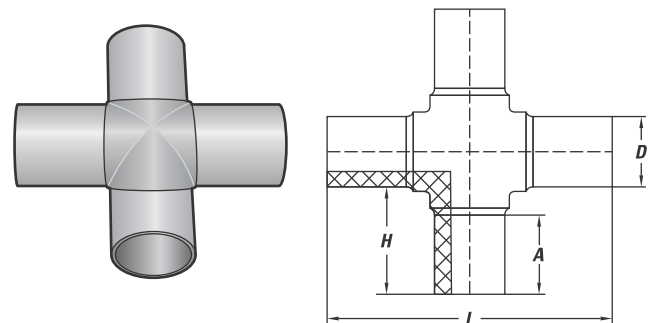

Tê đều - Equal Tee

Mã số Code	Kích cỡ Size	L	A	B	H
FPDBF/T50	50	170	55	55	82
FPDBF/T63	63	200	63	63	104
FPDBF/T75	75	230	70	70	114
FPDBF/T90	90	260	79	79	133
FPDBF/T110	110	290	82	82	145
FPDBF/T125	125	315	87	87	160
FPDBF/T140	140	345	92	92	170
FPDBF/T160	160	325	75	75	170
FPDBF/T180	180	420	105	105	225
FPDBF/T200	200	377	84	84	200
FPDBF/T225	225	484	120	120	230
FPDBF/T250	250	517	120	120	265
FPDBF/T280	280	590	140	140	300
FPDBF/T315	315	615	125	125	310
FPDBF/T355	355	630	120	120	350
FPDBF/T400	400	670	120	120	360

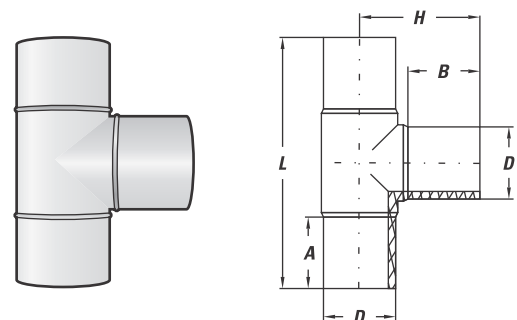

Tê thu - Reducing Tee

Mã số Code	Kích cỡ Size (D1 x D2)	L	A	B	H
FPDBF/TT5032	50 x 32	165	55	55	81
FPDBF/TT6325	63 x 25	168	63	45	85
FPDBF/TT6332	63 x 32	172	63	45	87
FPDBF/TT6340	63 x 40	180	63	50	93
FPDBF/TT6350	63 x 50	190	63	55	96
FPDBF/TT7532	75 x 32	180	70	39	90
FPDBF/TT7540	75 x 40	205	70	45	93
FPDBF/TT7550	75 x 50	205	70	55	100
FPDBF/TT7563	75 x 63	225	70	63	107
FPDBF/TT9032	90 x 32	215	79	45	105
FPDBF/TT9040	90 x 40	220	79	50	108
FPDBF/TT9050	90 x 50	230	79	55	110
FPDBF/TT9063	90 x 63	245	79	63	118
FPDBF/TT9075	90 x 75	252	79	70	126
FPDBF/TT11032	110 x 32	220	82	50	115
FPDBF/TT11040	110 x 40	230	82	50	119
FPDBF/TT11050	110 x 50	238	82	55	123
FPDBF/TT11063	110 x 63	250	82	63	118
FPDBF/TT11075	110 x 75	264	82	70	137
FPDBF/TT11090	110 x 90	275	82	79	135
FPDBF/TT12563	125 x 63	320	87	63	143
FPDBF/TT12575	125 x 75	314	87	70	152
FPDBF/TT12590	125 x 90	309	87	79	151
FPDBF/TT125110	125 x 110	318	87	82	160
FPDBF/TT140110	140 x 110	315	92	82	164
FPDBF/TT140125	140 x 125	330	92	87	167
FPDBF/TT16063	160 x 63	275	98	63	153
FPDBF/TT16075	160 x 75	287	98	70	167
FPDBF/TT16090	160 x 90	300	98	79	175
FPDBF/TT160110	160 x 110	325	98	82	175
FPDBF/TT160125	160 x 125	335	98	87	181
FPDBF/TT160140	160 x 140	345	98	92	186
FPDBF/TT18090	180 x 90	338	105	79	181
FPDBF/TT180110	180 x 110	355	105	82	187
FPDBF/TT180125	180 x 125	365	105	87	191
FPDBF/TT180140	180 x 140	380	105	92	196
FPDBF/TT180160	180 x 160	400	105	98	202
FPDBF/TT20063	200 x 63	305	112	63	176
FPDBF/TT20075	200 x 75	310	112	70	183
FPDBF/TT20090	200 x 90	330	112	79	191
FPDBF/TT200110	200 x 110	355	112	82	196
FPDBF/TT200125	200 x 125	370	112	87	201
FPDBF/TT200160	200 x 160	420	112	98	207
FPDBF/TT22590	225 x 90	345	120	79	207
FPDBF/TT225110	225 x 110	365	120	82	212
FPDBF/TT225160	225 x 160	417	120	98	212
FPDBF/TT225180	225 x 180	433	95	86	209
FPDBF/TT25090	250 x 90	395	129	79	218
FPDBF/TT250110	250 x 110	395	129	82	216
FPDBF/TT250125	250 x 125	410	129	87	221
FPDBF/TT250160	250 x 160	398	95	81	218
FPDBF/TT250180	250 x 180	460	129	105	245
FPDBF/TT250200	250 x 200	379	75	112	254
FPDBF/TT28090	280 x 90	410	140	79	235
FPDBF/TT280110	280 x 110	430	140	82	238
FPDBF/TT280160	280 x 160	480	140	98	254
FPDBF/TT280200	280 x 200	520	140	112	268
FPDBF/TT280225	280 x 225	545	140	122	278
FPDBF/TT280250	280 x 250	570	140	129	285

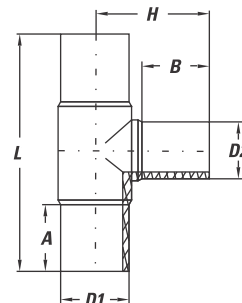
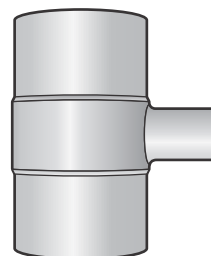

Tê thu - Reducing Tee

Mã số Code	Kích cỡ Size	L	A	B	H
FPDBF/TT31590	315 x 90	420	150	79	255
FPDBF/TT315110	315 x 110	442	150	82	255
FPDBF/TT315160	315 x 160	450	130	77	247
FPDBF/TT315180	315 x 180	503	150	105	291
FPDBF/TT315200	315 x 200	455	110	95	285
FPDBF/TT315225	315 x 225	550	150	120	292
FPDBF/TT315250	315 x 250	460	80	80	248
FPDBF/TT355250	355 x 250	620	120	120	290
FPDBF/TT355315	355 x 315	620	120	120	290
FPDBF/TT400200	400 x 200	670	130	150	380
FPDBF/TT400315	400 x 315	670	130	150	380
FPDBF/TT400355	400 x 355	670	130	150	380

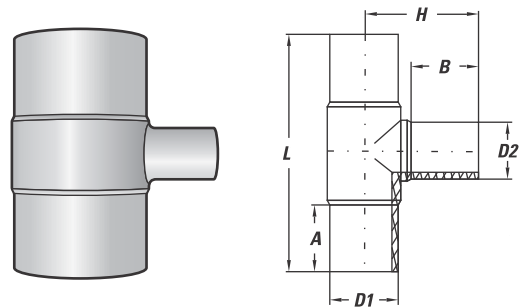

Nối thu - Reducer

Mã số Code	Kích cỡ Size	L	A	B
FPDBF/RS6325	63 x 25	139	63	55
FPDBF/RS6332	63 x 32	147	63	55
FPDBF/RS6340	63 x 40	141	63	55
FPDBF/RS6350	63 x 50	150	63	55
FPDBF/RS7532	75 x 32	149	70	55
FPDBF/RS7550	75 x 50	143	70	55
FPDBF/RS7563	75 x 63	150	70	63
FPDBF/RS9032	90 x 32	163	79	55
FPDBF/RS9040	90 x 40	162	79	55
FPDBF/RS9050	90 x 50	161	79	55
FPDBF/RS9063	90 x 63	168	79	63
FPDBF/RS9075	90 x 75	169	79	70
FPDBF/RS11040	110 x 40	169	82	55
FPDBF/RS11050	110 x 50	166	82	55
FPDBF/RS11063	110 x 63	173	82	63
FPDBF/RS11075	110 x 75	181	82	70
FPDBF/RS11090	110 x 90	177	82	79
FPDBF/RS12563	125 x 63	189	87	63
FPDBF/RS12590	125 x 90	183	87	79
FPDBF/RS125110	125 x 110	185	87	82
FPDBF/RS14090	140 x 90	224	92	79
FPDBF/RS140110	140 x 110	220	92	82
FPDBF/RS16032	160 x 32	202	98	70
FPDBF/RS16063	160 x 63	195	98	63
FPDBF/RS16075	160 x 75	204	98	70
FPDBF/RS16090	160 x 90	212	98	79
FPDBF/RS160110	160 x 110	211	98	82
FPDBF/RS160125	160 x 125	216	98	87
FPDBF/RS18090	180 x 90	231	110	79
FPDBF/RS180110	180 x 110	219	110	82
FPDBF/RS180125	180 x 125	233	105	87
FPDBF/RS180160	180 x 160	229	105	87
FPDBF/RS20063	200 x 63	210	112	63
FPDBF/RS20090	200 x 90	220	108	79
FPDBF/RS200110	200 x 110	228	112	82
FPDBF/RS200125	200 x 125	220	112	90
FPDBF/RS200160	200 x 160	226	112	85
FPDBF/RS200180	200 x 180	245	112	105
FPDBF/RS22590	225 x 90	226	105	79
FPDBF/RS225110	225 x 110	245	105	82
FPDBF/RS225160	225 x 160	249	105	90

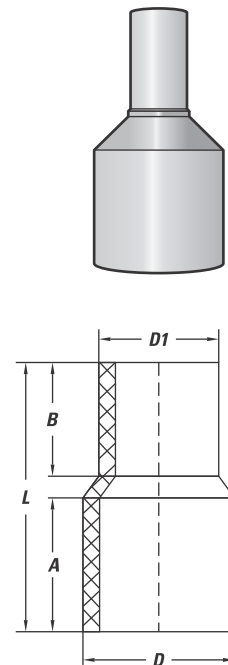

Nối thu - Reducer

Mã số Code	Kích cỡ Size	L	A	B
FPDBF/RS225180	225 x 180	249	105	90
FPDBF/RS225200	225 x 200	246	105	90
FPDBF/RS25090	250 x 90	224	112	79
FPDBF/RS250110	250 x 110	221	108	82
FPDBF/RS250125	250 x 125	234	109	87
FPDBF/RS250160	250 x 160	244	110	98
FPDBF/RS250180	250 x 180	237	110	105
FPDBF/RS250200	250 x 200	250	110	103
FPDBF/RS250225	250 x 225	231	105	90
FPDBF/RS280160	280 x 160	257	107	85
FPDBF/RS280225	280 x 225	247	110	85
FPDBF/RS280250	280 x 250	247	110	90
FPDBF/RS31590	315 x 90	240	115	79
FPDBF/RS315110	315 x 110	241	115	82
FPDBF/RS315160	315 x 160	254	115	98
FPDBF/RS315180	315 x 180	253	115	100
FPDBF/RS315200	315 x 200	253	115	92
FPDBF/RS315225	315 x 225	245	115	90
FPDBF/RS315250	315 x 250	246	115	90
FPDBF/RS355200	355 x 200	270	100	100
FPDBF/RS355250	355 x 250	270	100	100
FPDBF/RS355280	355 x 280	260	100	100
FPDBF/RS355315	355 x 315	240	100	100
FPDBF/RS400200	400 x 200	260	100	100
FPDBF/RS400250	400 x 250	250	100	100
FPDBF/RS400315	400 x 315	250	100	100
FPDBF/RS400355	400 x 355	250	100	100
FPDBF/RS450200	450 x 200	260	100	100
FPDBF/RS450250	450 x 250	260	100	100
FPDBF/RS450315	450 x 315	250	100	100
FPDBF/RS450355	450 x 355	250	100	100
FPDBF/RS450400	450 x 400	240	100	100
FPDBF/RS500400	500 x 400	250	100	100
FPDBF/RS500450	500 x 450	250	100	100
FPDBF/RS560500	560 x 500	260	100	100
FPDBF/RS630500	630 x 500	260	100	100
FPDBF/RS710630	710 x 630	250	100	100
FPDBF/RS800710	800 x 710	250	100	100

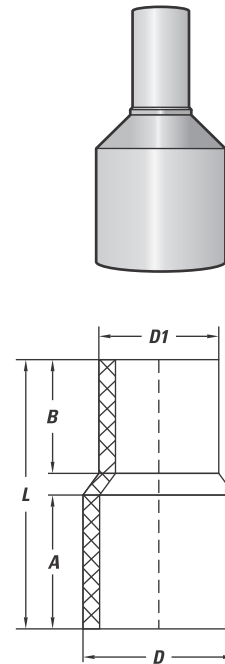

Nối góc 90° - Elbow 90°

Mã số Code	Kích cỡ Size	L	A
FPDBF/GV50	50	120	55
FPDBF/GV63	63	133	63
FPDBF/GV75	75	163	70
FPDBF/GV90	90	182	79
FPDBF/GV110	110	214	82
FPDBF/GV125	125	240	87
FPDBF/GV140	140	244	88
FPDBF/GV160	160	258	80
FPDBF/GV180	180	297	97
FPDBF/GV200	200	308	97
FPDBF/GV225	225	367	115
FPDBF/GV250	250	362	100
FPDBF/GV280	280	433	130
FPDBF/GV315	315	460	125
FPDBF/GV355	355	540	150
FPDBF/GV400	400	600	180

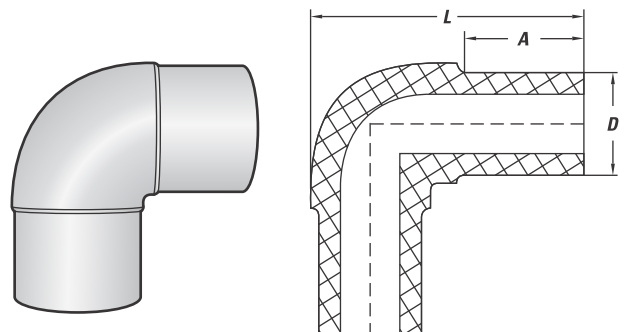

Nối góc 45° - Elbow 45°

Mã số Code	Kích cỡ Size	L	A	B
FPDBF/CH63	63	160	63	79
FPDBF/CH75	75	180	70	89
FPDBF/CH90	90	228	79	114
FPDBF/CH110	110	246	82	118
FPDBF/CH125	125	248	87	115
FPDBF/CH160	160	310	98	138
FPDBF/CH180	180	340	100	159
FPDBF/CH200	200	355	112	167
FPDBF/CH225	225	398	120	173
FPDBF/CH250	250	420	129	192
FPDBF/CH315	315	510	150	220

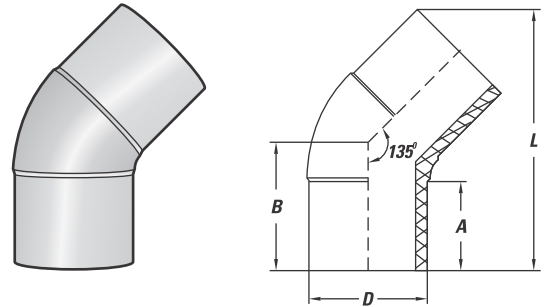

Đầu nối bằng bích - Flange adaptor

Mã số Code	Kích cỡ Size	L	A	B
FPDBF/AF2044	20 x 44	83	62	7
FPDBF/AF2544	25 x 44	83	61	8
FPDBF/AF3267	32 x 67	83	62	10
FPDBF/AF4077	40 x 77	78	61	12
FPDBF/AF5087	50 x 87	88	71	12
FPDBF/AF63110	63 x 110	88	70	12
FPDBF/AF75121	75 x 121	94	75	13
FPDBF/AF90137	90 x 137	98	76	18
FPDBF/AF110158	110 x 158	106	81	18
FPDBF/AF125158	125 x 158	130	103	21
FPDBF/AF140187	140 x 187	128	99	22
FPDBF/AF160212	160 x 212	135	104	26
FPDBF/AF180212	180 x 212	137	101	29
FPDBF/AF200268	200 x 268	154	113	34
FPDBF/AF225267	225 x 267	144	108	29
FPDBF/AF250320	250 x 320	156	120	29
FPDBF/AF280323	280 x 323	168	128	35
FPDBF/AF315370	315 x 370	173	133	33
FPDBF/AF355432	355 x 432	173	132	33
FPDBF/AF400482	400 x 482	182	132	32
FPDBF/AF450525	450 x 525	185	129	47
FPDBF/AF500580	500 x 580	211	144	47
FPDBF/AF560685	560 x 685	180	125	47
FPDBF/AF630685	630 x 685	205	145	50
FPDBF/AF630720	630 x 720	205	145	50
FPDBF/AF710800	710 x 800	185	110	56
FPDBF/AF800905	800 x 905	185	110	56
FPDBF/AF9001005	900 x 1005	185	110	56
FPDBF/AF10001100	1000 x 1100	185	110	56

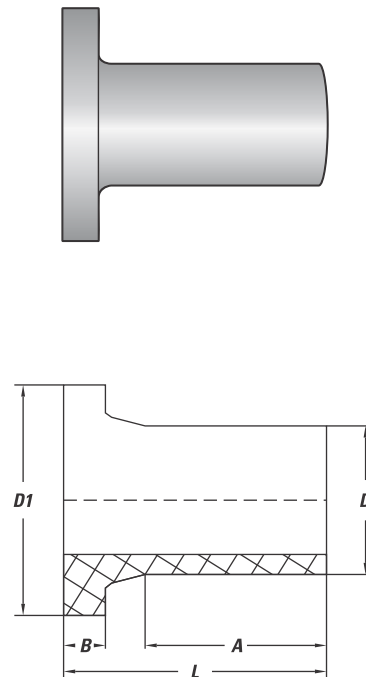

Phụ kiện hàn điện - Electro Fusion Fittings
Nối thẳng - E/F Coupling

Mã số Code	Kích cỡ Size
FPDEF/N20	20
FPDEF/N25	25
FPDEF/N32	32
FPDEF/N40	40
FPDEF/N50	50
FPDEF/N63	63
FPDEF/N75	75
FPDEF/N90	90
FPDEF/N110	110
FPDEF/N125	125
FPDEF/N160	160
FPDEF/N180	180
FPDEF/N200	200
FPDEF/N250	250
FPDEF/N315	315
FPDEF/N400	400
FPDEF/N500	500

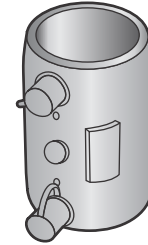

Nối thu - E/F Reducer

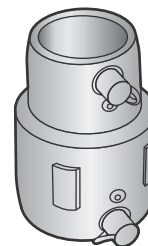
Mã số Code	Kích cỡ Size
FPDEF/NT4032	40 x 32
FPDEF/NT5032	50 x 32
FPDEF/NT5040	50 x 40
FPDEF/NT6332	63 x 32
FPDEF/NT6340	63 x 40
FPDEF/NT6350	63 x 50
FPDEF/NT7563	75 x 63
FPDEF/NT9063	90 x 63
FPDEF/NT9075	90 x 75
FPDEF/NT11050	110 x 50
FPDEF/NT11063	110 x 63
FPDEF/NT11075	110 x 75
FPDEF/NT11090	110 x 90
FPDEF/NT12590	125 x 90
FPDEF/NT16050	160 x 50
FPDEF/NT16063	160 x 63
FPDEF/NT16075	160 x 75
FPDEF/NT16090	160 x 90
FPDEF/NT160110	160 x 110
FPDEF/NT20050	200 x 50
FPDEF/NT20063	200 x 63
FPDEF/NT20075	200 x 75
FPDEF/NT20090	200 x 90
FPDEF/NT200110	200 x 110
FPDEF/NT200160	200 x 160
FPDEF/NT25063	250 x 63
FPDEF/NT25075	250 x 75
FPDEF/NT25090	250 x 90
FPDEF/NT250110	250 x 110
FPDEF/NT250160	250 x 160
FPDEF/NT250200	250 x 200
FPDEF/NT315200	315 x 200
FPDEF/NT315250	315 x 250
FPDEF/NT400315	400 x 315

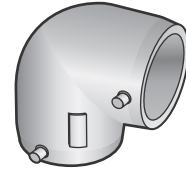

Nối góc 90° - E/F 90° Elbow

Mã số Code	Kích cỡ Size
FPDEF/G25	25
FPDEF/G32	32
FPDEF/G40	40
FPDEF/G50	50
FPDEF/G63	63
FPDEF/G75	75
FPDEF/G90	90
FPDEF/G110	110
FPDEF/G125	125
FPDEF/G160	160
FPDEF/G180	180
FPDEF/G200	200
FPDEF/G250	250
FPDEF/G315	315
FPDEF/G400	400



Nối góc 45° - E/F 45° Elbow

Mã số Code	Kích cỡ Size
FPDEF/GH32	32
FPDEF/GH40	40
FPDEF/GH50	50
FPDEF/GH63	63
FPDEF/GH75	75
FPDEF/GH90	90
FPDEF/GH110	110
FPDEF/GH125	125
FPDEF/GH160	160
FPDEF/GH180	180
FPDEF/GH200	200
FPDEF/GH250	250
FPDEF/GH315	315
FPDEF/GH400	400

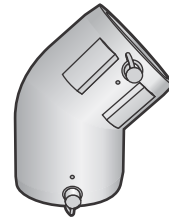

Tê - E/F Tee

Mã số Code	Kích cỡ Size
FPDEF/T20	20
FPDEF/T32	32
FPDEF/T40	40
FPDEF/T50	50
FPDEF/T63	63
FPDEF/T75	75
FPDEF/T90	90
FPDEF/T110	110
FPDEF/T125	125
FPDEF/T160	160
FPDEF/T180	180
FPDEF/T200	200
FPDEF/T250	250
FPDEF/T315	315
FPDEF/T400	400

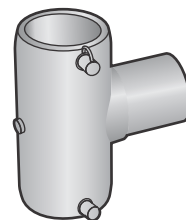

Tê thu - E/F Reducing Tee

Mã số Code	Kích cỡ Size
FPDEF/TT3220	32 x 20
FPDEF/TT3225	32 x 25
FPDEF/TT4020	40 x 20
FPDEF/TT4025	40 x 25
FPDEF/TT4032	40 x 32
FPDEF/TT5020	50 x 20
FPDEF/TT5025	50 x 25
FPDEF/TT5032	50 x 32
FPDEF/TT5040	50 x 40
FPDEF/TT6320	63 x 20
FPDEF/TT6325	63 x 25
FPDEF/TT6332	63 x 32
FPDEF/TT6340	63 x 40
FPDEF/TT6350	63 x 50
FPDEF/TT9040	90 x 40
FPDEF/TT9050	90 x 50
FPDEF/TT9063	90 x 63
FPDEF/TT9075	90 x 75
FPDEF/TT11050	110 x 50
FPDEF/TT11063	110 x 63
FPDEF/TT11075	110 x 75
FPDEF/TT11090	110 x 90
FPDEF/TT12563	125 x 63
FPDEF/TT12575	125 x 75
FPDEF/TT12590	125 x 90
FPDEF/TT125110	125 x 110
FPDEF/TT16050	160 x 50
FPDEF/TT16063	160 x 63
FPDEF/TT16075	160 x 75
FPDEF/TT16090	160 x 90
FPDEF/TT160110	160 x 110
FPDEF/TT20050	200 x 50
FPDEF/TT20063	200 x 63
FPDEF/TT20075	200 x 75
FPDEF/TT20090	200 x 90
FPDEF/TT200110	200 x 110
FPDEF/TT200160	200 x 160
FPDEF/TT25050	250 x 50
FPDEF/TT25063	250 x 63
FPDEF/TT25075	250 x 75
FPDEF/TT25090	250 x 90
FPDEF/TT250110	250 x 110
FPDEF/TT250160	250 x 160
FPDEF/TT250200	250 x 200
FPDEF/TT31590	315 x 90
FPDEF/TT315110	315 x 110
FPDEF/TT315160	315 x 160
FPDEF/TT315200	315 x 200
FPDEF/TT315250	315 x 250
FPDEF/TT400110	400 x 110
FPDEF/TT400160	400 x 160
FPDEF/TT400200	400 x 200
FPDEF/TT400250	400 x 250
FPDEF/TT400315	400 x 315

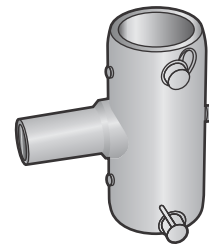

Bích chặn - E/F Flange (Steel Tray)

Mã số Code	Kích cỡ Size
FPVEF/SB110	110
FPVEF/SB160	160
FPVEF/SB200	200
FPVEF/SB250	250
FPVEF/SB315	315
FPVEF/SB400	400

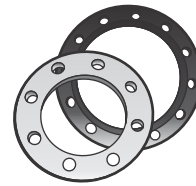

Đai kẹp thẳng - E/F Straight Saddle

Mã số Code	Kích cỡ Size
FPVEF/STS9063	90 x 63
FPVEF/STS11063	110 x 63
FPVEF/STS12563	125 x 63
FPVEF/STS16063	160 x 63
FPVEF/STS20063	200 x 63
FPVEF/STS20090	200 x 90
FPVEF/STS25090	250 x 90
FPVEF/STS315110	315 x 110
FPVEF/STS315160	315 x 160

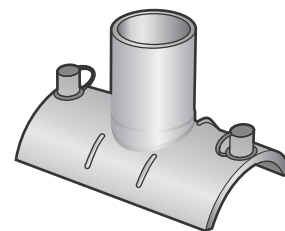

Đai kẹp góc - E/F Tapping Saddle

Mã số Code	Kích cỡ Size
FPVEF/STS6332	63 x 32
FPVEF/STS9063	90 x 63
FPVEF/STS11063	110 x 63
FPVEF/STS12563	125 x 63
FPVEF/STS16063	160 x 63
FPVEF/STS20063	200 x 63
FPVEF/STS20090	200 x 90
FPVEF/STS25090	250 x 90
FPVEF/STS315110	315 x 110
FPVEF/STS315160	315 x 160

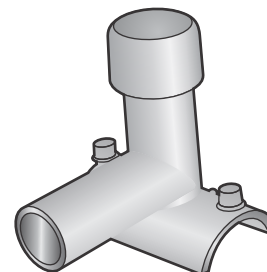

Đai kẹp chặn - E/F Stop Saddle

Mã số Code	Kích cỡ Size
FPVEF/SS90	90
FPVEF/SS110	110
FPVEF/SS125	125
FPVEF/SS160	160
FPVEF/SS200	200
FPVEF/SS250	250
FPVEF/SS315	315

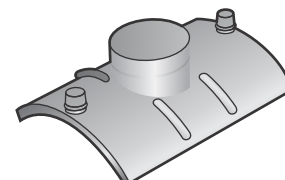

SỬ DỤNG HÀN ĐIỆN NỐI ỐNG - *ELECTRO FUSION JOINT*

Các bước sử dụng máy hàn điện cực - *Step: use electro fusion welding machine*

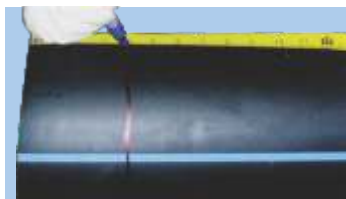

1. Vệ sinh và đánh dấu

Lau sạch mối nối, đánh dấu độ sâu mối hàn

1. *Clean and mark*

Clean up the connection part, mark the inserting depth.



2. Cạo

Cạo và đánh bóng bề mặt mối nối

2. *Scrape*

Scrape and polish the joint surface



3. Sắp xếp các phụ kiện vào ống

3. *Align and restrain the fittings to the pipes*



4. Cắm các điện cực vào

Cắm các điện cực máy hàn vào các cực trên phụ kiện, phần nối sẽ bị nóng chảy. Ngắt điện khi thấy nhựa chảy qua lỗ quan sát

4. *Apply electric current*

Apply the electric current to the fittings, the joining parts will be heated and melted, turn off the current when there is flowing in the observation hole.



5. Làm nguội

Phải cố định mối nối khi làm nguội

5. *Cool*

Cool without movement or pressure.

Ghi chú: Khi nối ống, điện áp và thời gian hàn phải tuân thủ theo thông số kỹ thuật của nhà sản xuất máy hàn cung cấp.

Note: While connecting, the heating voltage and time should comply with manufacture's technical stipulations of Electro Fusion Welding Machine.

HƯỚNG DẪN SỬ DỤNG MÁY HÀN ĐỐI ĐẦU

Nhiệt độ hàn: 230°C

Quy cách	Áp lực ép (kg/cm ²)	Thời gian gia nhiệt (giây)	Thời gian làm mát (giây)	Quy cách	Áp lực ép (kg/cm ²)	Thời gian gia nhiệt (giây)	Thời gian làm mát (giây)
90	23	56	150	225	28	112	292
110	24	68	190	250	29	115	300
125	25	80	220	280	29	119	310
140	25	87	245	315	32	125	350
160	27	95	260	355	32	128	360
180	27	99	272	400	34	130	380
200	28	105	285	450	34	135	390

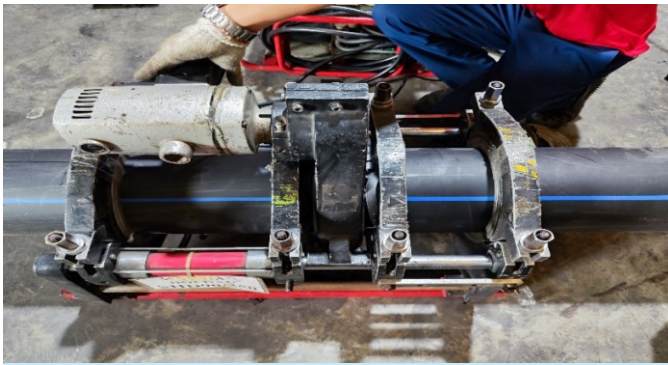

Bước 1: Gá đặt 2 cây ống lên máy, căn chỉnh để tâm 2 cây ống trùng nhau. Sau đó đưa máy bào vào để bào 2 đầu ống.

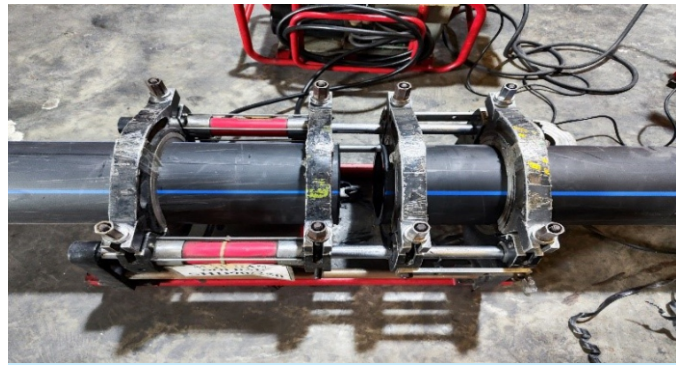

Bước 2: Kiểm tra 2 đầu mặt ống sau khi bào, đảm bảo bề mặt ống được bào nhẵn và phẳng.

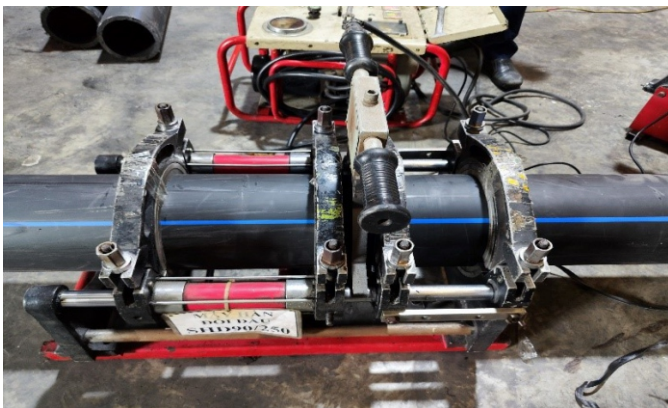

Bước 3: Đưa tấm gia nhiệt vào để gia nhiệt vào 2 đầu ống cần hàn.

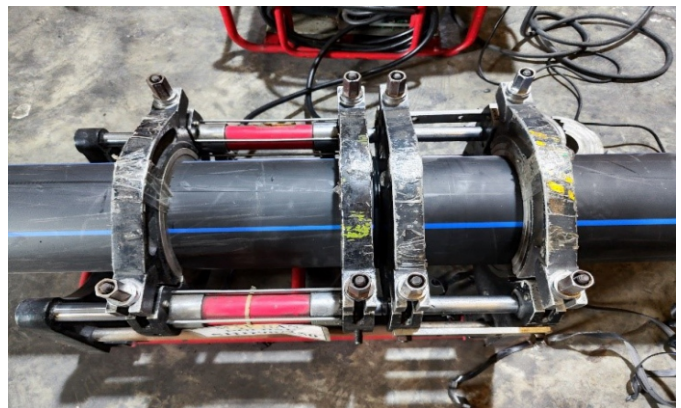

Bước 4: Khi đủ thời gian thì tháo tấm gia nhiệt và ép 2 đầu ống cần hàn lại với nhau.

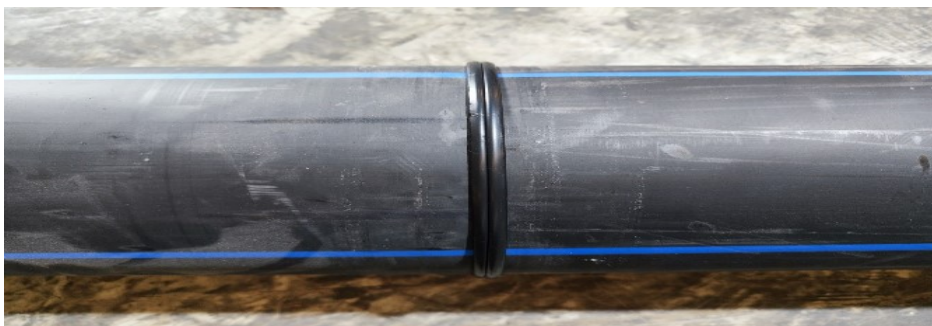

Bước 5: Kiểm tra thành phẩm mối hàn. Mối hàn chắc chắn, không cong vênh.